

SPEED TOUCH HOME

User Manual



Status Released

Change Note B D Fa a22855

Short Title CD-UG Speed Touch Home

All rights reserved. Passing on and copying of this document, use and communication of its contents not permitted without written authorization from Alcatel.

Contents

1	Welcome to the Speed Touch Home	7
1.1	Conventions	8
2	Speed Touch Home Tour	9
2.1	Delivery Check	10
2.2	Speed Touch Home at a Glance	11
2.2.1	ADSL Exposed	11
2.2.2	Front Panel and Rear Panel	12
2.2.3	LEDs	12
2.2.4	Ethernet and ATMF-25	13
2.3	System Requirements	13
2.4	Packet Services	14
2.4.1	IEEE 802.1D Transparent Bridging	14
2.4.2	PPPoA-to-PPTP Relaying	14
2.4.3	ATM	14
3	Connecting the Speed Touch Home	15
3.1	Connecting the Ethernet Interface	16
3.2	Connecting the ATMF Interface	18
3.3	Connecting the ADSL Interface	19
3.4	Connecting the Power Adapter	19
4	IEEE 802.1D Transparent Bridging	21
4.1	Getting Started with Bridging	22
4.2	Bridging Configuration	22
4.3	Using Bridging	22
5	PPPoA-to-PPTP Relaying for Microsoft Windows	23
5.1	Getting Started with PPPoA-to-PPTP Relaying	24
5.2	Requirements	24
5.3	Configuring Dial-Up Networking for Microsoft Windows 9x (or later)	25
5.4	Using PPPoA-to-PPTP Relaying for Microsoft Windows 9x (or later)	27
5.4.1	Establishing a PPPoA/PPTP Connection ..	27
5.4.2	Releasing a PPPoA/PPTP Connection	27
5.5	Downloading and Installing Dial-Up Networking Upgrade for Microsoft Windows 95	28
5.6	Advanced PPPoA-to-PPTP Relaying	29
5.6.1	Local Tunneling	29

5.6.2	Advanced PPPoA/PPTP Connections	30
5.7	Configuring and Using PPTP Tunnelling on Platforms running Microsoft Windows NT	31
5.7.1	Installing PPTP on a Windows NT Platform	31
5.7.2	Creating a New PPTP Phonebook Entry .	33
5.7.3	Logging on to a VPN Server through a PPTP Tunnel Session	36
5.7.4	Tearing Down a PPTP Tunnel	36
6	Lost Speed Touch Home	37
6.1	Resetting Speed Touch Home's IP Address	38
6.1.1	Ping-of-Life	38
6.2	Set to Manufacturing Defaults	41
6.2.1	Ping-to-Defaults	41
6.2.2	Push Button	42
7	Speed Touch Home Local Configuration	43
7.1	Web Interface	44
7.1.1	Configuring your Web Browser	44
7.1.2	Speed Touch Home's Web Pages Principles	44
7.1.3	Initial Setup Web Page	47
7.1.4	The System Setup Web Page	49
7.1.5	The Phonebook Web Page	50
7.1.6	The Routing Web Page	52
7.1.7	The PPTP Connections Web Page	54
7.1.8	The Bridging Web Page	56
7.1.9	The DHCP Web Page	59
7.1.10	The DNS Web Page	63
7.1.11	The Software Upgrade Web Page	64
7.2	Command Line Interface via Telnet	65
8	Troubleshooting	67
	Abbreviations	69
	Appendix A Product Code Tables	71
	Appendix B Hardware Reference	75
	Appendix C Speed Touch Home Default Settings .	79
	Appendix D Safety	81
	Appendix E Agency Regulatory Notices	85

Figures

Figure 1	Delivery Check	10
Figure 2	POTS and ADSL Frequency Spectra	11
Figure 3	Front Panel of the STHome with 5 Light Emitting Diodes (LEDs)	12
Figure 4	Rear Panel of the STHome	12
Figure 5	Rear panel with Ethernet Interface (a), or both ATMF-25 and Ethernet (b)	13
Figure 6	Rear View for connecting the STHome	16
Figure 7	Single PC Configuration	16
Figure 8	Multiple PC Configuration	17
Figure 9	Rear View for connecting the STHome	18
Figure 10	Make New Connection Window	25
Figure 11	VPN Server Window	26
Figure 12	'Connect To' (a) and 'Connected To' (b) Window	27
Figure 13	PPPoA-to-PPTP Advanced Network	29
Figure 14	'PPTP Configuration' Window	31
Figure 15	'Remote Access Setup' Window	32
Figure 16	'Add RAS Device' Window	32
Figure 17	'Configure Port Usage' Window	33
Figure 18	'Dial-Up Networking' Window	34
Figure 19	'New Phonebook Entry Wizard' Window	34
Figure 20	'Server' Window	35
Figure 21	'Connect T' Window	36
Figure 22	Example of a Ping-of-Life Procedure	40
Figure 23	Welcome Web Page	44
Figure 24	'Initial Setup' Web Page	47
Figure 25	'System Setup' Web Page	49
Figure 26	Authentication Window	49
Figure 27	'Phonebook' Web Page	50
Figure 28	'Routing' Web Page	52
Figure 29	'Routing' Web Page, IP Address Table	53
Figure 30	'PPTP Connections' Web Page	54
Figure 31	PPP ATM Format (RFC 2364:PPP over AAL5).	55
Figure 32	PPP/PPTP Tunnel Format.	55
Figure 33	'Bridge Configurations' Web Page	57
Figure 34	'Bridge Data' Web Page, Static and Dynamic MAC	59
Figure 35	'DHCP Configuration' Web Page	60
Figure 36	Advanced 'DHCP Server Configuration' Web Page	61
Figure 37	'DNS Configurations' Web Page	63
Figure 38	'Software Upgrade' Web Page	64
Figure 39	STHome Product Code	71
Figure 40	MDI-X Internal Crossover	77
Figure 41	MDI-X to MDI-X External Crossover	77
Figure 42	EC Declaration of Conformity	86

Tables

Table 1	STHome LED Status Overview	12
Table 2	IP address Classes and Default Netmasks	48
Table 3	Default Phonebook Entries	51
Table 4	"X Field" Specification	72
Table 5	"Y Field" Specification	72
Table 6	"Z Field" Specification	72
Table 7	"S Field" Specification	73
Table 8	"H Field" Specification	73
Table 9	Connector Pinout	75
Table 10	Power Adapters for STHome	76
Table 11	Default Bridging Phonebook Entries	79
Table 12	Bridging Parameters	79
Table 13	Default Relaying Phonebook Entries	80
Table 14	ATMF VPI/VCI Values	80
Table 15	Ethernet VPI/VCI Values	80

1 Welcome to the Speed Touch Home

Welcome to the Alcatel **Speed Touch™** Asymmetric Digital Subscriber Line (ADSL) modem.

From now on, your online experience will be greatly enhanced due to the high speed Internet access that ADSL technology delivers.

Over the past five years, the **Alcatel ADSL** has evolved from the drawing boards to operational products. This technological breakthrough coincides with an ever increasing demand for better Internet access.

This **Speed Touch™Home User Manual** will be your partner in exploiting the features of this highly advanced product.

Prior to connecting the **Speed Touch™Home**, read the Safety Instructions (See Appendices D and E).

For readability, the **Speed Touch™Home** will be referred to as **STHome** in this User Manual.

1.1 Conventions

The following words and symbols mark special messages throughout this document:



WARNING: Text written in this manner indicates that failure to directions could cause bodily harm or loss of life.



CAUTION: Text written in this manner indicates that failure to directions could result in damage to equipment or loss of information.

Note Text written in this manner indicates that the following presents clarifying information, specific instructions, commentary, or interesting information.

2 Speed Touch Home Tour

Your **Speed Touch™Home** is an ADSL modem used for Internet access or remote Local Area Network (LAN) access via the ADSL Line.

This chapter aims to familiarize you with the **STHome**.

The topics are:

- ▶ Delivery Check
- ▶ **STHome** at a Glance:
 - ADSL Exposed
 - Front and Rear Panel
 - Light Emitting Diode (LED) Description
- ▶ System Requirements
- ▶ Packet Services.

2.1 Delivery Check

Prior to installation, inspect the **Speed Touch™ Home** for damage. Make sure the box contains all the components (See figure 1):

- ▶ The **Speed Touch™ Home**(*)
- ▶ Power supply adapter with 2m (6.56ft.) connecting cable
- ▶ 2m Ethernet/ATMF straight-through cable (RJ45/RJ45), referred to as the **LAN cable** in this document
- ▶ 2m (RJ11/RJ11, RJ14/RJ14) cable, referred to as the **ADSL cable**
- ▶ This User Manual.



Figure 1 Delivery Check

In the event of damaged or missing items, contact your local product dealer for further instructions.

Note (*) For product coding and physical differences, all available versions are described in Appendix A.

2.2 Speed Touch Home at a Glance

2.2.1 ADSL Exposed

ADSL is brand-new modem technology, used by the **Speed Touch™ Home**, unlocking the potential bandwidth of the widely available public telephone network.

ADSL is short for **Asymmetric Digital Subscriber Line**. This somewhat cryptic name is best explained in straightforward terms:

- ▶ **Line:** Because ADSL uses the ordinary existing copper line, known as “local loop”, that runs between your home or office premises and one of the telephone operators’ main switching exchanges, known as a central office.
- ▶ **Subscriber:** That’s you. Because this is what service providers or operators call their customers or end users.
- ▶ **Digital:** Because ADSL is used to transmit digital signals, just like those that make up computer files.
- ▶ **Asymmetric:** Because ADSL can transmit data much faster from the Internet towards the end user than the other way around. It is rather like having a major highway in one direction and a one-lane road in the other.

Because Plain Old Telephone Service (POTS) and ADSL occupy distinct frequency spectra (See figure 2), ADSL service can coexist with conventional telephone service.

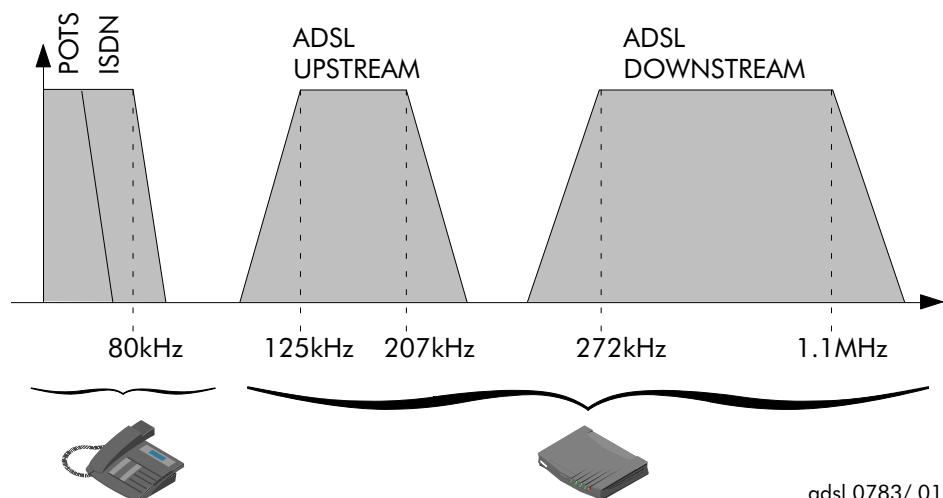

Figure 2 POTS and ADSL Frequency Spectra

2.2.2 Front Panel and Rear Panel

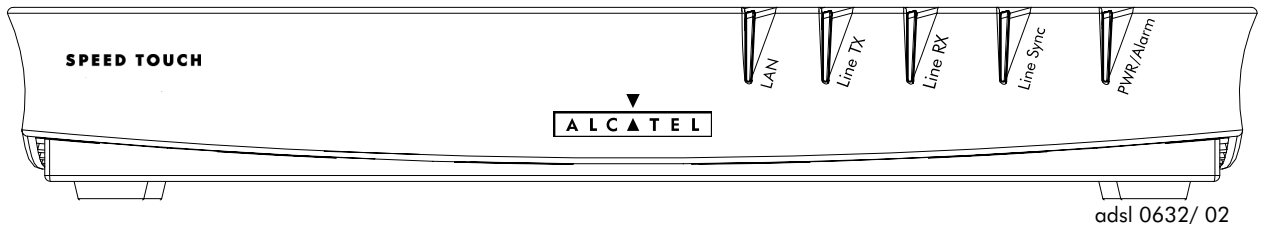

Figure 3 Front Panel of the STHome with 5 Light Emitting Diodes (LEDs)

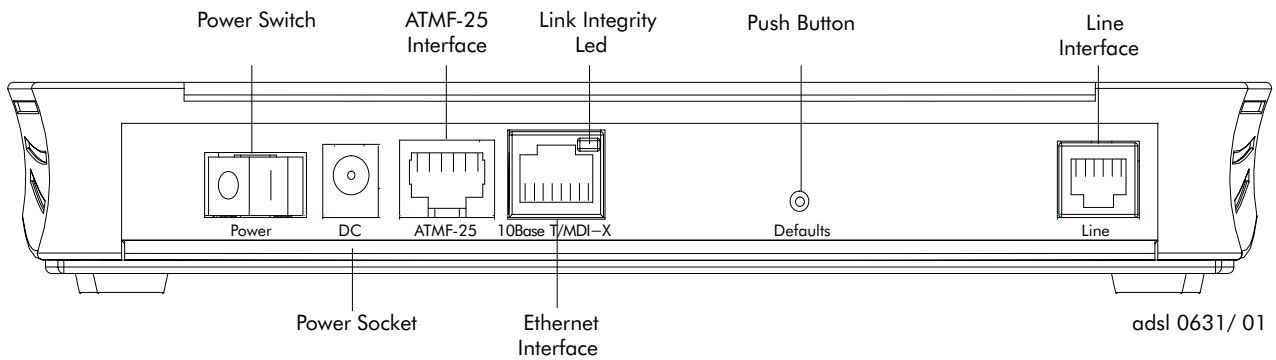

Figure 4 Rear Panel of the STHome

2.2.3 LEDs

Following table explains the functions of the front LEDs:

Table 1 STHome LED Status Overview

LED Name	LED Color	LED State	Explanation
LAN	green	flashing	data is flowing from/to the Ethernet interface
		off	no activity on the Ethernet interface
Line TX	green	flashing	ATM cells are being sent over the ADSL line
		off	no transmission activity
Line RX	green	flashing	ATM cells are being received via the ADSL Line
		off	no reception activity
Sync	green	on	ADSL line synchronization achieved
		flashing	during initialization of the ADSL Line
PWR/Alarm	green	on	power on, normal operation
		flashing	power on, Power On Self Test (POST) pending
		on	power on, POST failed

2.2.4 Ethernet and ATMF-25

There are 2 **Speed Touch™ Home** versions: Ethernet only and Ethernet + ATMF-25 (See figures 5 (a) and (b)).

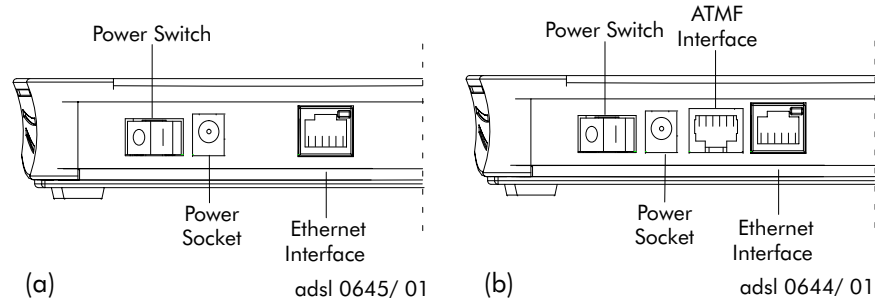

Figure 5 Rear panel with Ethernet Interface (a), or both ATMF-25 and Ethernet (b)

Ethernet will be your natural choice for networking.

The ATMForum 25.6 interface provides excellent protocol transparency and Native Asynchronous Transfer Mode (ATM) application support.

2.3 System Requirements

ADSL ADSL service must be enabled on your telephone line.

Ethernet

- ▶ A Personal Computer (PC)/workstation with an Ethernet 10Base-T PC-Network Interface Card (NIC)
- ▶ For local networking, a 10Base-T hub and the necessary connection cables

ATMF-25

- ▶ A PC/workstation with an ATMF-25 PC-NIC
- ▶ For advanced networking, an ATM switch supporting ATMF-25

Operating System

- ▶ If the **STHome** is used in *Bridging* mode, it does not put any requirements on the Operating System (OS).
- ▶ When the **STHome** is used in *PPPoA-to-PPTP Relaying* mode, the OS must support local tunneling based on PPP/PPTP.
- ▶ In case the *ATMF-25 interface* is used, see the manual of your ATMF-25 PC-NIC for additional requirements.

Local Configuration

- ▶ Command Line Interface (CLI): Telnet Application
- ▶ HTTP/HTML: A Web browser

2.4 Packet Services

2.4.1 IEEE 802.1D Transparent Bridging

The **Speed Touch™ Home Transparent Bridging** packet service offers complete protocol transparency and has inherent configuration simplicity. Yet it provides excellent forwarding performance.

2.4.2 PPPoA-to-PPTP Relaying

In contrast to Bridging, *PPPoA-to-PPTP Relaying* supports a session concept. It offers identification, authentication and encryption. Similar to Bridging, PPPoA-to-PPTP Relaying is multiprotocol and offers complete Transmission Control Protocol (TCP)/Internet Protocol (IP) transparency.

2.4.3 ATM

The **STHome** ADSL modem relies on ATM technology for its wide area communications.

On top of ADSL, both Bridging and PPPoA-to-PPTP Relaying use ATM Virtual Channels (VCs). **Virtual Path Identifier (VPI)/Virtual Channel Identifier (VCI)** are 2 numbers that together uniquely identify the Virtual Channel (VC) and Virtual Path (VP) which will be used by the **STHome** to access the remote end of the network

The remote organization, i.e. ADSL provider, Internet Service Provider (ISP), or corporate has to provide following information about the ATM layer:

- ▶ The type of packet service, i.e. Bridged, or PPP/PPTP, on which your ADSL service is enabled at the remote end of the connection
- ▶ The ATM/ATM Adaption Layer (AAL)5 encapsulation method for the Protocol Data Unit (PDU), i.e. LLC SNAP, or VC MUX, per packet service
- ▶ The VPI/VCI values per packet service.

Additionally, the remote organization may provide you with:

- ▶ A **User Account**, i.e. User Name and Password, for Internet access via an ISP or corporate location access.

Additional User Accounts might be required for access to specific secured servers.

Note In the event **STHome** default settings differ with the provided information, change the settings accordingly.

3 Connecting the Speed Touch Home

This chapter describes how to connect your **Speed Touch™Home**.

The topics discussed are:

- ▶ Connecting the Ethernet Interface
- ▶ Connecting the ATMF-25 Interface
- ▶ Concurrent Use of both Interfaces
- ▶ ADSL Connectivity
- ▶ **STHome** Power Supply.

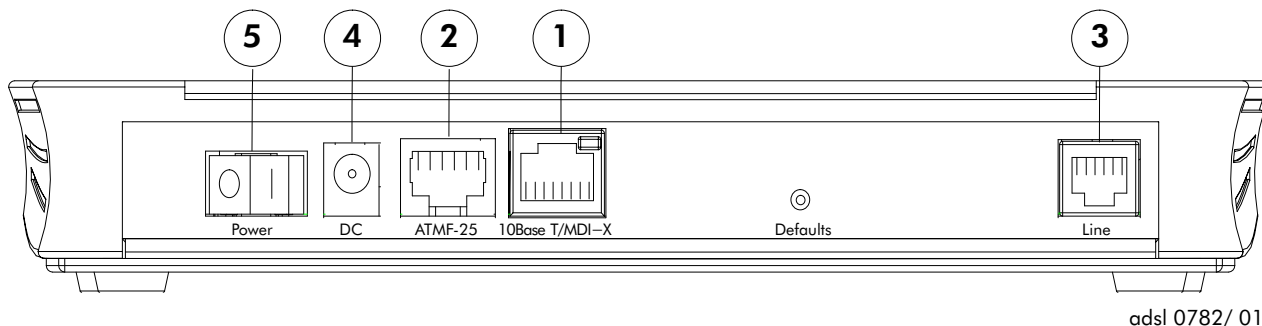

Figure 6 Rear View for connecting the STHome

Following connectors, switches and cables are involved:

- ▶ ① The 10Base-T/MDI-X Ethernet interface
- ▶ ② The (optional) ATM Forum-25 interface
- ▶ ③ The ADSL line interface
- ▶ ④ The power receptacle
- ▶ ⑤ The power switch
- ▶ The ADSL cable
- ▶ The LAN cable
- ▶ The power adapter.

Please follow the numbers on figures 6 and 9 to complete the connection procedure for the **Speed Touch™ Home**.

3.1 Connecting the Ethernet Interface

The Ethernet interface available on the **STHome** is a 10Base-T **Half Duplex** interface of type MDI-X. The **STHome** can either be

- ▶ *Connected to a single PC.*

Use the *LAN cable*, to connect the Ethernet interface ① to the Ethernet interface on your PC.

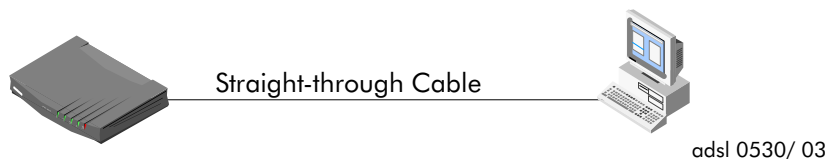

Figure 7 Single PC Configuration

- ▶ *Connected to a workgroup hub.*

Use a *crossover LAN cable* to connect the *Ethernet interface* **1** to a Medium Dependent Interface – Crossed (MDI-X) Ethernet interface of your hub.

Use *straight-through LAN cables* to make the connections between the MDI-X hub interfaces and the PC's or workstation's Medium Dependent Interface (MDI) Ethernet interfaces.

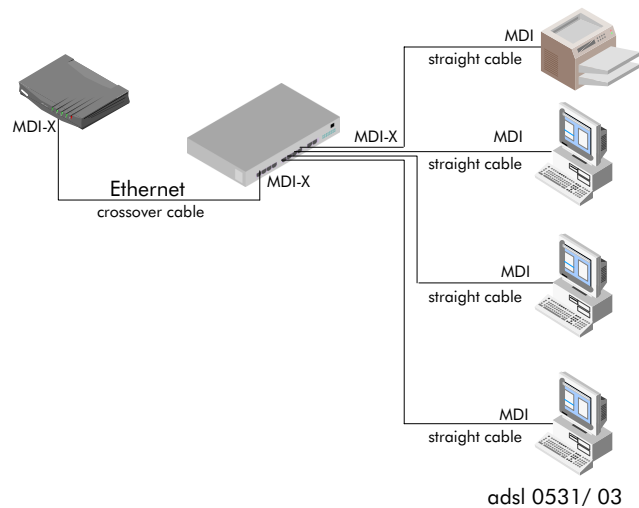

Figure 8 Multiple PC Configuration



10Base-T Half Duplex Interfacing

Make sure the 10Base-T interface(s) of your PC(s) are configured for either **Auto Negotiation** or **Half Duplex**.

Never configure the PC-NIC 10Base-T Ports for Full-Duplex !

Assuming the **Speed Touch™ Home** and the PC or hub are properly powered on, the Link Integrity LEDs on both PC and/or hub interfaces and **STHome** should be continuously green.

This indicates that the link is correct. If not, check the cable layouts according to Appendix B.

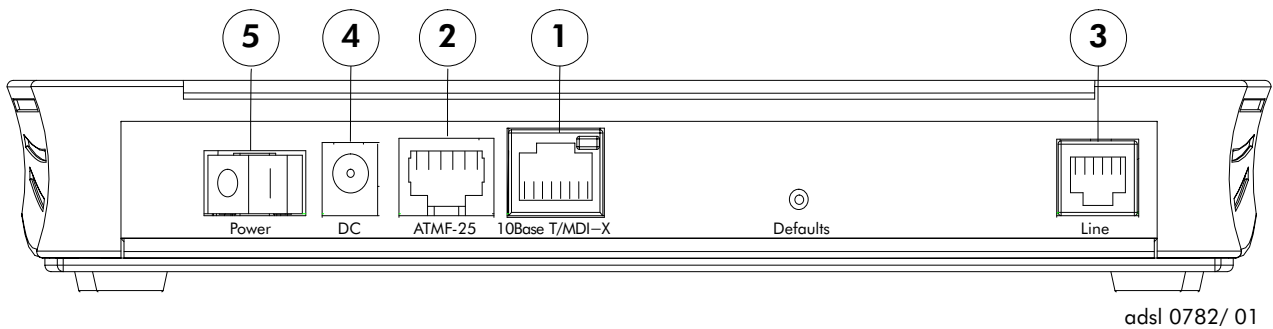

Figure 9 Rear View for connecting the STHome

3.2 Connecting the ATMF Interface

The (optional) *ATMF interface* (2) is an ATM Forum 25.6 Mbit/s compliant interface of type *ATM Network Equipment*.

- ▶ Connect the PC (with an ATMF PC-NIC card of type *ATM End Equipment*) directly to the ATMF interface (2) via the *LAN cable*.
- ▶ To connect multiple PCs to the ATMF interface, an ATM switch is required. Use a *crossover cable* between ATMF interface (2) and the ATM switch, since both are of type "Network Equipment".

Note The Ethernet and ATMF-25 interfaces of the **Speed Touch™Home** are designed for **concurrent use**. There is no performance penalty on this simultaneous use except for the sharing of upstream and downstream ADSL bandwidth.

3.3 Connecting the ADSL Interface

Prior to connecting the **Speed Touch™Home**, you **MUST** contact your ADSL provider. He will inform you whether the ADSL service is already enabled. If not, he will advice you on how to proceed.

Firstly a **central splitter** or **distributed filters** must be installed in order to prevent the ADSL channel from disturbing the phone channel and vice versa.



In all cases contact your ADSL Service Provider about splitter/filter installation !

Public telephone lines carry voltages that **can cause electric shock**. Only install splitter/filters yourself if these are qualified for that purpose. Other splitter/filters may **only** be installed by **qualified service personnel**.

- ▶ Plug the ADSL cable into the 'Line' interface **3** .
- ▶ Plug the other end into the wall socket terminating ADSL service.

3.4 Connecting the Power Adapter

The **STHome** is delivered with a modular external power adapter.

See Appendix B for connector layout and output specifications.

Proceed as follows to connect the power adapter :

- ▶ Plug the power adapter's coaxial jack into receptacle **4** .
- ▶ Plug the power adapter into the mains outlet.
- ▶ Turn on the **STHome** with the power switch **5** .
- ▶ Check the front panel LEDs on top of the **STHome** (See section 2.2.2). The LED marked "PWR/Alarm" initially flashes red, indicating that the **STHome** is performing a self test.
- ▶ If the self test was successful, the "PWR/Alarm" indicator shows continuous green.
- ▶ At this point, the **STHome** is ready for ADSL service.

4 IEEE 802.1D Transparent Bridging

The **Speed Touch™Home** IEEE802.1D Bridging packet service offers complete protocol transparency and has inherent configuration simplicity. Yet it provides excellent forwarding performance.

The topics covered in this chapter include:

- ▶ Getting Started with Bridging
- ▶ Bridging Configuration
- ▶ Using Bridging.

4.1 Getting Started with Bridging

1. Connect your **Speed Touch™Home** and PC(s) as described in Chapter 3.
2. Configure *Public* IP addresses on your PC(s) according to the preferred method of your service provider: either static, or dynamic.
3. At this point you are online and applications can be started, e.g. a Web browser.

4.2 Bridging Configuration

Remote Organization Must support RFC1483 **Bridged PDU Encapsulation on ATM**.

Additionally it provides you with:

- ▶ the **VPI/VCI** values for Bridging service.
- ▶ **In case of Internet access**, your ISP may:
 - Provide static IP parameters to be configured on your PC.
 - Require you to use DHCP on your PC. (Dynamic IP parameters are configured by a remote DHCP server)

Note : *Connectivity to multiple remote organizations*

Additional sets of these parameters need to be supplied.



Bridging & Dynamic Host Configuration Protocol (DHCP)

DHCP is by default **disabled** for the **SHome**.

This to avoid conflicts with the DHCP server of your ISP.

Bridge Port Configuration

The **SHome** comes with a preconfigured Bridge port **Br1**. As this port is put in **forwarding** state, frames can be transmitted and received **without** any configuration action.

If needed you can configure up to 4 additional ports via the **SHome** local web pages. For more, please read Chapter 7.

4.3 Using Bridging

From this point on, using Bridging is rather straight-forward. Start your Web browser and you are on the Internet. However, the remote organization might present you with a welcome screen asking for a User Name and Password prior to granting access to secured servers or the Internet.

5 PPPoA-to-PPTP Relaying for Microsoft Windows

In contrast to Transparent Bridging (See Chapter 4), providing “Always-On” type of connections, PPPoA-to-PPTP Relaying supports a session concept. It offers identification, authentication and encryption. Similar to Bridging, PPPoA-to-PPTP Relaying is multiprotocol and offers complete TCP/IP transparency.

And important advantage of PPPoA-to-PPTP relaying is that it avoids the complexity of a router, yet – to a certain extent – provides identical features

This chapter covers configuring and using the PPPoA-to-PPTP Relaying (PPPoA/PPTP) mode of the **Speed Touch™ Home**.

This chapter covers following topics:

- ▶ Getting started with PPPoA-to-PPTP Relaying
- ▶ Requirements for using PPPoA-to-PPTP Relaying
- ▶ Configuring Dial-Up Networking
- ▶ Using PPPoA-to-PPTP Relaying
- ▶ Upgrade Procedures for Windows 95 Users
- ▶ Advanced PPPoA-to-PPTP Relaying
- ▶ Configuring and using PPTP Tunneling with Windows NT.

5.1 Getting Started with PPPoA-to-PPTP Relaying

- Initial Configuration**
1. Connect your **Speed Touch™Home** and PC(s) as described in Chapter 3.
 2. Determine your PC's OS. If:
 - **Windows 98 (or later)** : Continue with step 4.
 - **Windows 95** : Continue with step 3.
 - **Windows NT** : Go to section 5.7.
 3. Download the Dial-Up Networking Upgrade for Windows 95 and install it as described in section 5.5.
 4. Configure a *Private* IP address on your PC, e.g. 10.0.0.1.
 5. Configure your PPP/PPTP Dial-Up connection icon(s) as described in section 5.3.
- Use**
6. Establish the connection by double clicking the icon of the appropriate PPP/PPTP connection (See section 5.4.1).
 7. You are now connected: start your application, e.g. a Web browser.

5.2 Requirements

Remote Organization Must support RFC2364 **PPP Encapsulation on ATM**.

Additionally, it provides you with:

- ▶ The **VPI/VCI** values for PPP service
- ▶ A **User Account** for access to its network or the Internet.

Should you want connectivity to multiple remote organizations, additional sets of these parameters need to be supplied.

STHome Comes with 4 preconfigured PPPoA/PPTP connections. Up to 12 concurrent virtual channels are supported; all can be assigned to PPP/PPTP. The actual number might be restricted by the ADSL provider.

Your Computer Must support the Point-to-Point Protocol (PPP) and Point-to-Point Tunneling Protocol (PPTP).

TCP/IP Prior to establishing PPTP tunnels, IP addresses must be properly configured in both machines, i.e. the PC and **STHome**, initiating and terminating the PPTP tunnel.

Therefore, configure a static IP address, or enable DHCP-client in your PC(s). The **STHome** DHCP server is by default disabled. In case you enable the DHCP-client in your PC, you also must enable a DHCP server, e.g. the **STHome**.

5.3 Configuring Dial-Up Networking for Microsoft Windows 9x (or later)

To configure a new connection on a Microsoft Windows 9x (or later) platform, to your headquarters or an ISP, proceed as follows:

1. Activate the 'Make New Connection' application by

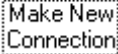
double-clicking  in the 'Dial-Up Networking' folder. 

2. The 'Welcome to Dial-Up Networking' window appears (this window appears only during first time use of the 'Make New Connection' application). Click .

3. The 'Make New Connection' window appears (see figure 10).

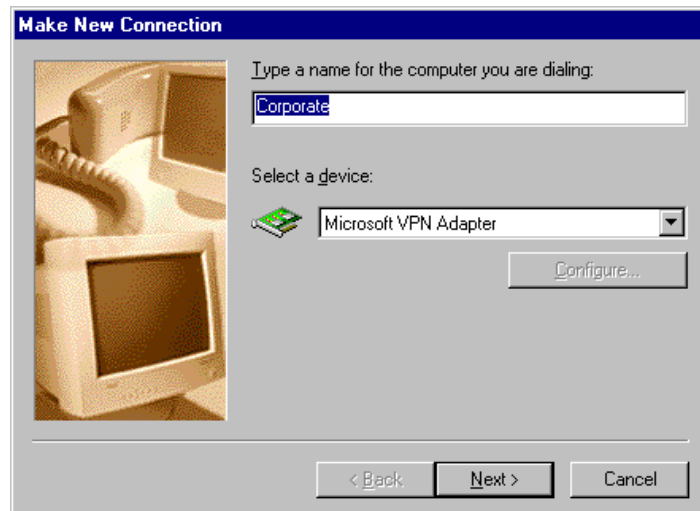



Figure 10 Make New Connection Window

In the first input field, type the name or alias of the organization you are connecting to. This name will appear below the newly created icon at the end of this procedure.

In the 'Select a Device' listbox, you must select the 'Microsoft Virtual Private Network (VPN) Adapter' for PPTP tunneling.

Note **Windows 95 Users** : If Dial-Up Networking has not been upgraded, you cannot select the 'Microsoft VPN Adapter'. Upgrade according section 5.5.

Click .

4. The 'VPN Server' window appears (See figure 11). Enter the hostname or IP address of your **Speed Touch™ Home**. Its default IP address is 10.0.0.138, the default DNS hostname is "SpeedTouch".

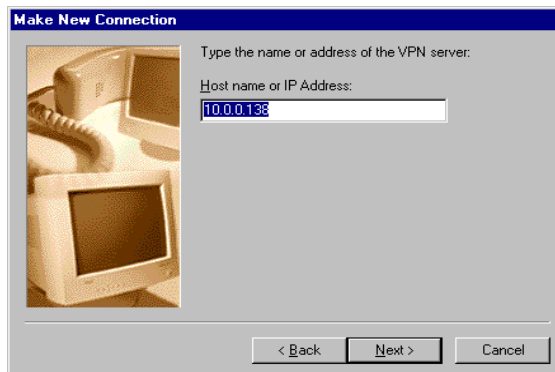

Figure 11 VPN Server Window

Click .

5. A window appears announcing that you have successfully installed a new Dial-Up Networking Connection. Click to end. A new icon with the name of the connection that you have just created, will be added to your Dial-Up Networking folder.

6. Right-click the Dial-Up icon and select 'Properties'.
7. The 'Properties' window appears. Select the 'Server Types' tab.
8. Disable the protocols that you will not use, e.g. IPX/SPX, NETBEUI.

Now your connection is configured.

9. For your convenience, you can create a shortcut to the icon. Drag the newly created 'Corporate' Icon to your desktop; the program will ask if you want to create a shortcut to the selected item. Select and a copy of the selected icon will appear on your desktop.

Note **Creating multiple icons for multiple destinations**

For every destination you can create a unique icon. This can be accomplished by repeating the steps – starting with step 3. – for each destination.

Note See section 5.6 for advanced PPPoA-to-PPTP Relaying concepts.

5.4 Using PPPoA-to-PPTP Relaying for Microsoft Windows 9x (or later)

5.4.1 Establishing a PPPoA/PPTP Connection

After configuring the connection, establish the connection as follows:

1. Double-click either the appropriate icon in the 'Dial-Up Networking' folder or its shortcut on the desktop.
2. The 'Connect To' window appears (See figure 12(a)).

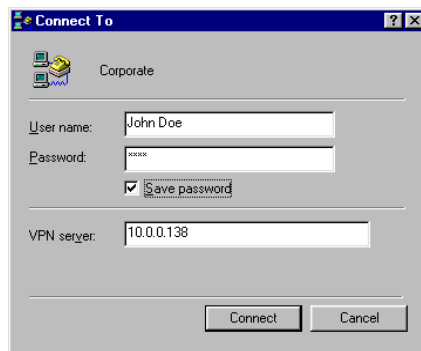

(a)

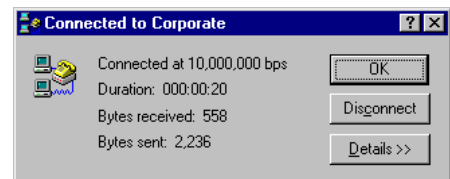

(b)

Figure 12 'Connect To' (a) and 'Connected To' (b) Window

Fill in the 'User name' and 'Password' and click .

3. The 'Connecting To' window appears shortly before being minimized in the System Tray.
4. You can now open your application, e.g. a Web browser.

Note While connected you can pop up the 'Connected To' window (see figure 12(b)) by double-clicking the minimized icon in the System tray.

Note To avoid entering your password each time, you can save it by ticking 'Save Password' (✓). The next time you establish this connection, both User Name and Password are displayed automatically. Make sure though you have logged in when booting Microsoft Windows 9x (or later).

5.4.2 Releasing a PPPoA/PPTP Connection

To release a PPPoA/PPTP connection, proceed as follows:

1. If minimized, double-click the connection icon in the system tray.
2. In the 'Connected To' window (See figure 12(b)), click .

The PPPoA/PPTP connection no longer exists.

5.5 Downloading and Installing Dial-Up Networking Upgrade for Microsoft Windows 95

This section explains how to download and install the *Windows Dial-Up Networking 1.3 Performance and Security Upgrade for Windows 95*.

To download the *Windows Dial-Up Networking 1.3 Performance and Security Upgrade for Windows 95* from the World Wide Web (WWW):

1. Browse to the Microsoft website at location 'http://www.microsoft.com' by entering this address in the Uniform Resource Locator (URL) field of your Web browser.
2. Click the 'Downloads' button in the Microsoft homepage's taskbar. You will be guided to Microsoft's 'Download Center'.

In this web page, select as Operating System. Click .

3. In the result list, look for the following title: [Dial-Up Networking Performance & Security Upgrade](#) and select it by clicking.

Note You can also use Microsoft's Search Tool to locate the Upgrade. Therefore, search for 'MSDUN13.EXE'.

4. A 'Read me first' web page pops up, informing how the download will progress.
5. After download, a 'Save As...' window pops up, asking you to specify a location for the MSDUN13.exe file to be downloaded.
6. Clicking executes the download.
7. Go to the location where you stored MSDUN13.exe and double-click it for installation of the upgrade.

After installation you have the fully updated Dial-Up Networking application, required to use PPPoA-to-PPTP Relaying.

You are now ready to configure the PPPoA/PPTP connections as described in section 5.3.

5.6 Advanced PPPoA-to-PPTP Relaying

5.6.1 Local Tunneling

The **Speed Touch™Home** allows local tunneling from behind an IP router. This requires a few special settings in both the **STHome** and your PCs/workstations.

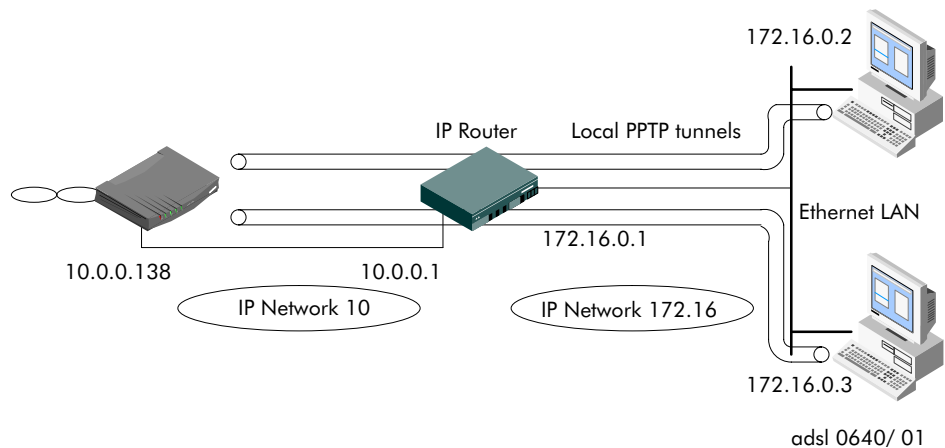

Figure 13 PPPoA-to-PPTP Advanced Network

► **STHome**

You must specify the default route for the **STHome** via the **STHome** local web pages. In this example, the IP address of the default router would be 10.0.0.1, which is the IP address of the Ethernet interface of the CPE router connected to the **STHome**.

► PCs or workstations:

For each PC you must add a route to their internal routing table. This route must point to the **STHome**. For PCs equipped with Microsoft Windows OSs, proceed as follows:

1. Select 'Start' from the Windows taskbar.
2. Select 'Programs'.
3. Select 'MS-DOS' prompt.
4. In the DOS window, execute the command:

```
route add <Destination IPaddress> <Gateway IPaddress>
```

In the example: `route add 10.0.0.138 172.16.0.1`

To verify IP connectivity, you can ping the **STHome**. If it responds, setting up PPTP tunnels is possible.

5.6.2 Advanced PPPoA/PPTP Connections

By default, the **Speed Touch™ Home** is configured for 4 PPPoA/ATM connections. The **STHome** is however capable of managing **up to 12 PPPoA/ATM channels simultaneously**. This can be achieved by deleting all other packet service entries.

However, check with your ISP, or corporate headquarters to ensure that these connections are cross-connected in the Wide Area Network (WAN) and consequently that end-to-end connectivity is assured.

Single Destination Two situations are possible:

▶ **Single ATM channel to a single destination**

In this scenario, the ISP supplied one ATM channel for connectivity. It is most applicable when a single PC is connected to the **STHome**.

▶ **Multiple ATM channels to a single destination**

In this scenario, the ISP supplied multiple ATM channels, all directing to the same destination. This implies that several PCs can connect to this destination at the same time (as long there is an idle channel left). Therefore, this is most applicable with a **STHome** connected to a LAN.

Multiple Destination Multiple remote organizations might be connected to your **STHome**, e.g., your private ISP(s) and your corporate headquarters.

In this case, the **STHome's** ATM channels will be split over both locations. For example, 6 ATM channels could be provisioned to your ISP and 6 channels to your corporate.

You need to check with your ISP and your corporate LAN administrator to verify which cross-connections exist between the ATM virtual channels and the locations.

Via the **STHome's** local web pages you can add these specific PPP/PPTP entries, named at will, in addition to the default 'RELAY_PPPx' entries. See section 7.1.5 for more.

These additional entries can be added in the 'VPN Server' field of the 'Connect To' window with their names, next to the Domain Name System (DNS) hostname or IP address of your **STHome** (See step 4. of the steplist in section 5.3).

If you establish this connection, the Dial-Up application will use this particular VC to connect to the remote access server.

5.7 Configuring and Using PPTP Tunnelling on Platforms running Microsoft Windows NT

This section describes how to create and setup a PPTP Dial-Up connection over standard telephone lines and Virtual Private Network connections over IP networks on a Windows NT platform.

Note Make sure that 'Microsoft Service Pack 3' has been installed on your PC before you start creating PPTP tunnel sessions.

5.7.1 Installing PPTP on a Windows NT Platform

Before you can start creating PPTP tunnels, you must install the PPTP networking protocol as follows:

1. Double-click 'Network' in 'Control Panel'.
2. The 'Network' Window appears. Select the 'Protocol' tab and click .
3. The 'Select Network Protocol' Window appears. Select the 'Point-to-Point Tunneling Protocol' from the list. Click .
4. Setup now needs to copy some Windows NT files and prompt you for the proper path. Specify the path and click . The installation will load all necessary PPTP files.
5. The 'PPTP Configuration' window appears (See figure 14), asking how many VPNs you want to enable for access to this server.

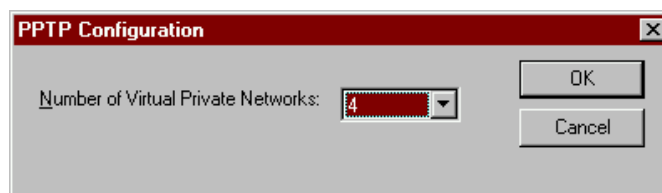

Figure 14 'PPTP Configuration' Window

Choose '4' (as an example) to create a maximum number of four remote PPTP concurrent connections to this Remote Access Services (RAS) server.

Click to continue.

- 6. A setup message appears.
Clicking initiates configuration of RAS.

Note You have now completed the first part of the installation, adding PPTP as a remote protocol. The remaining steps of the installation configure RAS for PPTP.

- 7. The 'Remote Access Setup' Window appears (See figure 15) and lists a modem that is already setup in RAS.
To add the new VPN ports to 'RAS', click .

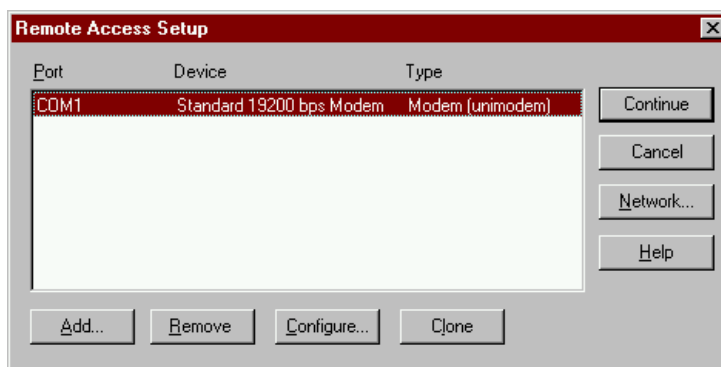

Figure 15 'Remote Access Setup' Window

- 8. The 'Add RAS Device' window appears (See figure 16). Each port must be added individually. To do so double-click on the correct port and click .

Repeat steps 7. and 8. until all VPN ports are listed in the 'Remote Access Setup' window.

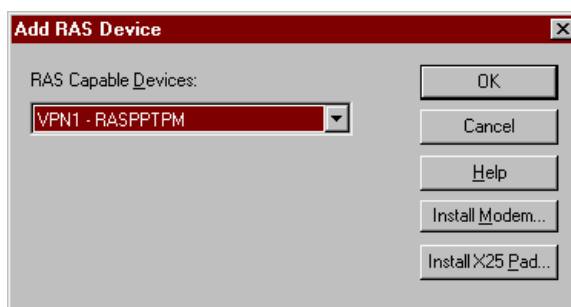

Figure 16 'Add RAS Device' Window

- 9. At this point, by default the ports are configured for dial-in only. To change this, select a port and click in the 'Remote Access Setup' window.

10. The 'Configure Port Usage' window appears (See figure 17).

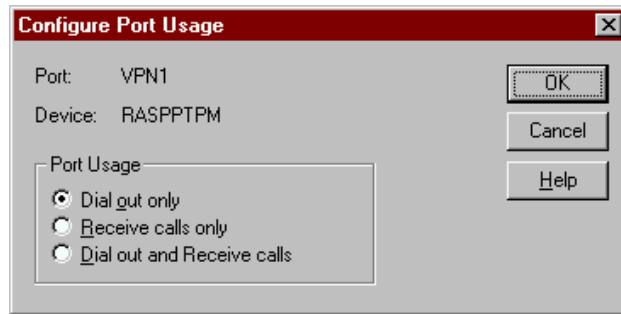
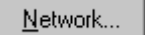

Figure 17 'Configure Port Usage' Window

Select the 'Dial-out only' option and click .

11. Steps 9. and 10. can be performed for each port (if necessary), then proceed with step 12.

12. In addition you can also define which PPTP tunneled protocols you will allow through the VPNs. To do so highlight each port and click .

In the 'Network Configuration' window enable or disable the protocols you require, and click .

Note You can enable or disable IP, IPX or NETBEUI sessions for each port.

13. Click  and finally .

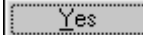
The PC will inform you it needs to be restarted in order to effect the changes. Click  to restart.

5.7.2 Creating a New PPTP Phonebook Entry

The following procedure tells how you can create a tunnel session for use with the Corporate LAN or dial-up transport. A tunnel session contains the IP address of a PPTP server and your user account information for that server. You can create as many tunnel definitions as you need for different accounts or different PPTP servers.

To create a PPTP tunnel session to your headquarters or a PPTP server:

1. Double-click 'Dial-Up Networking' in 'My Computer'.
2. The 'Dial-Up Networking' window appears (See figure 18).
The Phonebook entry selection box lists all existing PPTP tunnels if there already exist. Click **New...** to create a new tunnel.



Figure 18 'Dial-Up Networking' Window

3. The 'New Phonebook Entry Wizard' window appears (See figure 19).

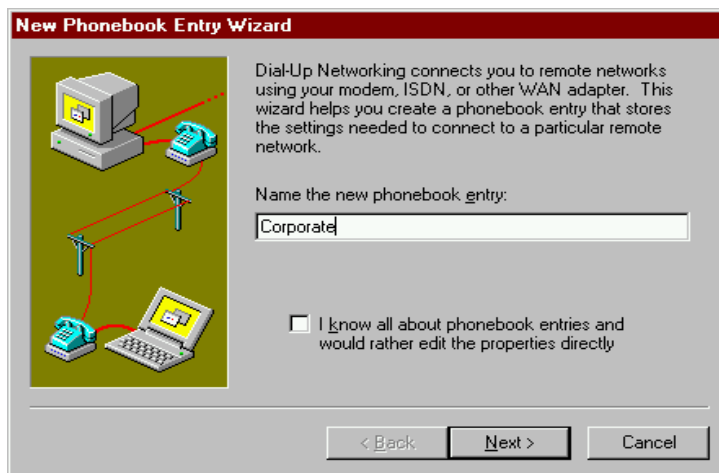

Figure 19 'New Phonebook Entry Wizard' Window

4. Enter a name for the tunnel you are creating (the PPTP tunnel will be saved in the phonebook under this name).
Click **Next >**.



5. The 'Server' window appears (See figure 20).
 Activate all the options that apply to your tunnel.
 Click .



Figure 20 'Server' Window

6. The 'Phone Number' window appears. You enter the 'Phone Number' of the dial-up server you are calling. Click .

Note **Multiple Phone Numbers :** You can assign more than one phone number to each entry. This might be useful if you have a pool of phone numbers to connect to. To do so click 'Alternates...'

7. The 'New Phonebook Entry Wizard' window appears. This window tells you that the new tunnel creation is successful.
 Click . The tunnel definition is saved and added to the Phonebook entries drop-down list.

5.7.3 Logging on to a VPN Server through a PPTP Tunnel Session

When the tunnel session to your VPN server has been created, proceed as follows to log on:



1. Double-click 'Dial-Up Networking' in 'My Computer'.
2. The 'Dial-Up Networking' window appears (See figure 18). Select the tunnel you want to set up in the phonebook selection box and click .
3. The 'Connect to' window appears (See figure 21). Enter your password for the VPN server (In case 'Save Password' is not ticked (✓)).



Figure 21 'Connect T' Window

4. Enter the optional information in the 'Domain' box. This is only required by some Microsoft NT VPN servers. Click .
5. The 'Connecting To Corporate' window appears. This window informs you of the status of the connection process. Once the connection is established, it is minimized.

5.7.4 Tearing Down a PPTP Tunnel

To uninstall a PPTP tunnel, proceed as follows :

1. Click the appropriate connection icon.
2. Click .

The network connection to your ISP has been disconnected.

6 Lost Speed Touch Home

Non accessibility to your **Speed Touch™Home** may occur if wrongly configured or simply by forgetting its IP address.

Due to the flexible nature of the **STHome**, you may end up in a situation where restoring all of the original defaults is the only solution.

The **STHome** has tools to cope with these situations:

Setting the IP address To set the IP address, without involving other configurational settings:

- ▶ *Ping-of-Life™*.

Setting to Manufacturing Defaults To perform a set to the manufacturing defaults, including the IP address:

- ▶ *Ping-to-Defaults™*
- ▶ Push Button.

6.1 Resetting Speed Touch Home's IP Address

6.1.1 Ping-of-Life

The *Ping-of-Life*[™] is a method to reset the IP address of the **Speed Touch**[™]**Home** without changing other settings.

The principle is fairly simple, a special ping packet will deliver an IP address to your **STHome**.

The steps to be performed are:

- ▶ Pre-configure the intended IP address and a special Medium Access Control (MAC) Group address in the ARP cache of one of your PCs.
- ▶ Reset your **STHome** and allow the POST to end (takes about 30 seconds). Now ping this IP address within 60 seconds.
- ▶ If everything goes well, your **STHome** has assimilated this IP address.
- ▶ Make this IP address permanent by saving the settings via the **STHome** local web pages.

Note Most TCP/IP packages support the *arp* and *ping* command. The *Ping-of-Life*[™] can be executed from any PC on your local network.



IP Addresses and Subnet Masks

Make sure that the intended **STHome** IP address and your PC have the same IP (sub)network number.

If not, the ping will be submitted with the MAC address of the default router instead of the special MAC Group address.

The procedure for Microsoft Windows platforms is described below. Small differences may occur for other platforms.

1. Power off the **Speed Touch™Home**.

2. Open a DOS window.

3. In this DOS window, execute the command:

```
arp -a
```

This command allows you to overview the current entries in the ARP cache.

4. Now add a static entry to the PC's ARP cache, according to the syntax below:

```
arp -s <STHome IP address> 01-90-D0-80-01-01
```

<STHome IP address> is a placeholder for the IP address to be assigned to the **Speed Touch™Home**.

In the subsequent example, 10.0.0.145 will be used.

The MAC address 01-90-D0-80-01-01 is a special MAC Group address from Alcatel on which the **STHome** will react.

In the example the command would be:

```
arp -s 10.0.0.145 01-90-D0-80-01-01
```

5. Verify if this step was successful by executing

```
arp -a
```

In the entries list, your `arp -s` command entry should be added.

6. Power on the **STHome** and wait for 30 seconds to allow the POST to end.

7. Ping the IP address you just entered in the ARP cache within 60 seconds:

```
ping <STHome IP address>
```

For this example the command is:

```
ping 10.0.0.145
```

8. If successful, the **Speed Touch™Home** has configured this IP address and will reply to the ping.

9. You may clear the entry in the ARP cache by issuing the following command:

```
arp -d <STHome IP address>
```

Leaving the entry in the ARP cache does not harm the general operation.

In figure 22 all these steps are shown as an example of resetting **STHome**'s IP Address to 10.0.0.145.

```

MS-DOS Prompt
Auto
C:\>arp -a
No ARP Entries Found
C:\>arp -s 10.0.0.145 01-90-d0-80-01-01
C:\>arp -a
Interface: 10.0.0.1 on Interface 0x3000004
Internet Address      Physical Address      Type
10.0.0.145           01-90-d0-80-01-01   static
C:\>ping 10.0.0.145
Pinging 10.0.0.145 with 32 bytes of data:
Reply from 10.0.0.145: bytes=32 time=3ms TTL=255
Reply from 10.0.0.145: bytes=32 time=1ms TTL=255
Reply from 10.0.0.145: bytes=32 time=1ms TTL=255
Reply from 10.0.0.145: bytes=32 time=3ms TTL=255
Ping statistics for 10.0.0.145:
    Packets: Sent = 4, Received = 4, Lost = 0 (0% loss),
    Approximate round trip times in milli-seconds:
        Minimum = 1ms, Maximum = 3ms, Average = 2ms
C:\>

```

Figure 22 Example of a Ping-of-Life Procedure

10. Browse to the **STHome** local web pages and click  to make the new IP address permanent.

TIP

'Ping -t' command

You can avoid waiting 30 and then 60 seconds by proceeding as follows:

1. If step 2. of the previous procedure is executed, continue as below:
2. Ping the IP address with the command:
`ping -t <STHome IP address>.`
3. Power on the **STHome**.
4. After the POST, the **STHome** will reply to the ping.
5. Terminate the continuous ping by pressing CTRL-C.
6. Save the IP address via the **STHome** local web pages.

Note

If your PC is equipped with multiple PC-NICs, make sure that the procedure is applied to the one connected to the **STHome**. Therefore modify the arp-syntax as follows:

```
arp -<a, s, d> <STHome IP address>
-N <interface IP address>
```

In this syntax, <Interface IP address> identifies the particular PC-NIC.

6.2 Set to Manufacturing Defaults

The following procedures will reset **all** of the **Speed Touch™Home**'s configurable values back to their defaults, including the IP address.



Ping-to-Defaults™ and Push button vs. Internal Settings

Be careful when using the Ping-to-Defaults™ command, or the push button as it destroys all changes previously made to the **STHome** internal settings.

Note A reset to defaults, also implies the **STHome**'s IP address is permanent reset to 10.0.0.138. It is possible that your **STHome** needs another IP address according your LAN configuration. Therefore, you may have to execute a *Ping-of-Life™*.

6.2.1 Ping-to-Defaults

The first method to reset all settings to the original defaults is the *Ping-to-Defaults™*.

The technique is identical to that used for the *Ping-of-Life™*, except that another MAC address is used, i.e. **01-90-D0-80-01-FF**.

The following steps will cause the **Speed Touch™Home** to revert to the default values:

1. Power off the **STHome**.
2. Add the following to the ARP cache:

```
arp -s <IP address within subnet> 01-90-D0-80-01-FF
```

This **<IP address within subnet>** can be any address within your subnet as long as it is not used by any other member of your local network.

3. Power on the **STHome** and wait for the POST to end.
4. Ping this same IP address :

```
ping <IP address within subnet>
```

5. You **must** clear the entry in the ARP cache by issuing the following command :

```
arp -d <IP address within subnet>
```

Note The IP address used to perform a Ping-to-Defaults™ is not assimilated by your **STHome**. The **STHome** will restart with the original defaults, including the default IP address 10.0.0.138.

6. If needed, reconfigure the **STHome**'s IP address.

6.2.2 Push Button

The small push button entitled "Defaults" is located on the rear panel of the **STHome**.

The procedure to revert **all** of the **STHome** configurable values back to their manufacturing defaults is as follows:

1. Make sure the **STHome** is powered on.
2. Use a pencil to press the push button at the back of the **STHome**.
3. Release the button. Via the flashing front panel LEDs, you will notice that the **STHome** will restart.
4. Finally, it will come online with default settings.
5. If needed, reconfigure **STHome**'s IP address.

7 Speed Touch Home Local Configuration

The **Speed Touch™Home** can be configured in 2 different ways:

- ▶ Using a Web Browser
- ▶ Through a Command Line Interface via Telnet.

7.1 Web Interface

The **Speed Touch™ Home** comes with integrated local configuration capabilities. This feature is based on the “Hyper Text Transfer Protocol (HTTP) Server/Web browser Concept”. It allows configuration of your **SHome** via Hyper Text Markup Language (HTML) pages, using a Web browser from any local PC attached on the LAN.

7.1.1 Configuring your Web Browser

To configure your **SHome**, make sure your Web browser is **not using a Proxy server**. The procedure to disable proxy settings depends on the browser that you are using.

After configuring your **SHome**, do not forget to reset your Web browser to its original settings !

7.1.2 Speed Touch Home’s Web Pages Principles

To access the **SHome**’s web pages proceed as follows:

1. Start the Web browser on your PC or workstation.
2. Contact the **SHome** by entering its IP address or DNS hostname in the URL field.
The default **SHome** address is 10.0.0.138, the hostname is “SpeedTouch”.
3. The ‘Welcome to the World of ADSL’ web page appears (see figure 23):

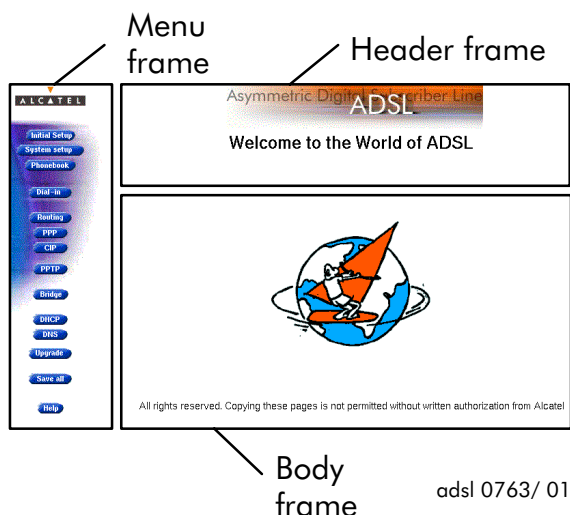

Figure 23 Welcome Web Page





Speed Touch™Home's web pages can be divided into three sections (See figure 23):

- ▶ A horizontal bar, referred to as **Menu frame** hereafter
- ▶ A vertical pane, referred to as **Header frame** hereafter
- ▶ The user field, referred to as **Body frame** hereafter

Header frame

The **Header frame** is present in all of the **STHome** web pages.

It contains the following command buttons:

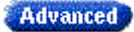
-  To let changes made, take effect.
-  To save changes in permanent storage.
-  To recall manufacturing default settings within the content of the topic. Use  to make these default settings persistent again.
-  To reveal the more advanced items for a particular topic.

Menu frame

The **Menu frame** is generic for all **STHome**'s local web pages. Each button represents a **STHome** configuration subject.



To return to the *Welcome* web page.



Pops up the '*Initial Setup*' web page, allowing you to configure user defined IP parameters for the **STHome** (See section 7.1.3).

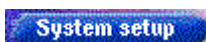

Pops up '*System Setup*' web page, allowing you to set a password for restricting access to the **STHome** (See section 7.1.4).

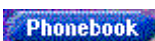

Pops up the '*Phonebook*' web page, allowing you to consult or store connectivity information (See section 7.1.5).

Routing

Pops up the 'Routing' web page, allowing you to configure settings for very specific IP configurations (See section 7.1.6).

PPTP

Pops up the 'PPTP Configuration' web page, allowing you to set the PPTP parameters (See section 7.1.7).

Bridge

Pops up the 'Bridge Configuration' web page, allowing you to set the Bridging parameters (See section 7.1.8).

DHCP

Pops up the 'DHCP Configuration' web page, allowing you to configure **Speed Touch™Home**'s DHCP server/client model (See section 7.1.9).

DNS

Pops up the 'DNS Configuration' web page, allowing you to configure **STHome**'s DNS server (See section 7.1.10).

Upgrade

Pops up the 'Software Upgrade' web page, allowing you to upgrade the **STHome** software from the local network. (See section 7.1.11)

Save all

To save all the changes made in permanent memory.

Help

To access the online help web pages.

On most pages, **Action** fields are found.

Two actions can be performed via these fields:

▶ **Add** (**Add**)

▶ **Delete** (**Delete**)

7.1.3 Initial Setup Web Page

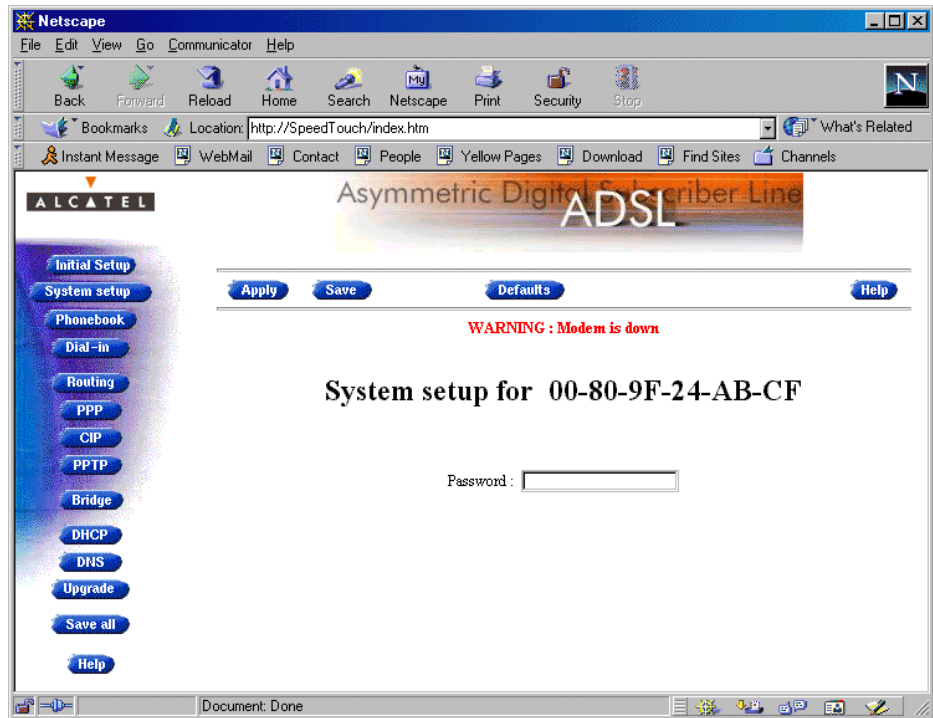

Figure 24 'Initial Setup' Web Page

The **Speed Touch™ Home** relies heavily on the TCP/IP Protocol for its internal operation. IP requires a minimum set of parameters for its proper operation:

- ▶ IP address
- ▶ Netmask

These IP parameters, which are for local communication only, can be configured manually using this 'Initial Setup' web page, or dynamically via the 'DHCP Configuration' web page (See section 7.1.9 for more).

As the **STHome** IP layer supports logical multi-homing (one interface supporting multiple IP addresses), the manually configured IP address and the dynamically required IP address are both active at the same time.

Parameters on this page:

- ▶ **STHome MAC address**

The unique Medium Access Control (MAC) address of the **STHome** is displayed as "Initial setup for xx-xx-xx-xx-xx-xx". It is used to identify your **STHome** on the LAN.

▶ **IP address**

In this field you can configure a user defined IP address for the **Speed Touch™ Home**. This IP address will show up as **“User”** in the 'Routing' web page.

▶ **Netmask / Subnet Mask**

For applying subnetting in your local network, fill out a suitable Subnet Mask.

Below you can find the default Netmasks for the various IP address classes:

Table 2 IP address Classes and Default Netmasks

IP Address Class	Default Netmask	Example (Private IP)
A (1.x.x.x to 126.x.x.x)	255.0.0.0	10.x.x.x
B (128.0.x.x to 191.255.x.x)	255.255.0.0	172.16.x.x
C (192.0.0.x to 223.255.255.x)	255.255.255.0	192.168.x.x

7.1.4 The System Setup Web Page

The 'System Setup' web page allows you to protect your **Speed Touch™ Home** settings by configuring a system password. Just type it into the 'Password' field. A User ID is not required.

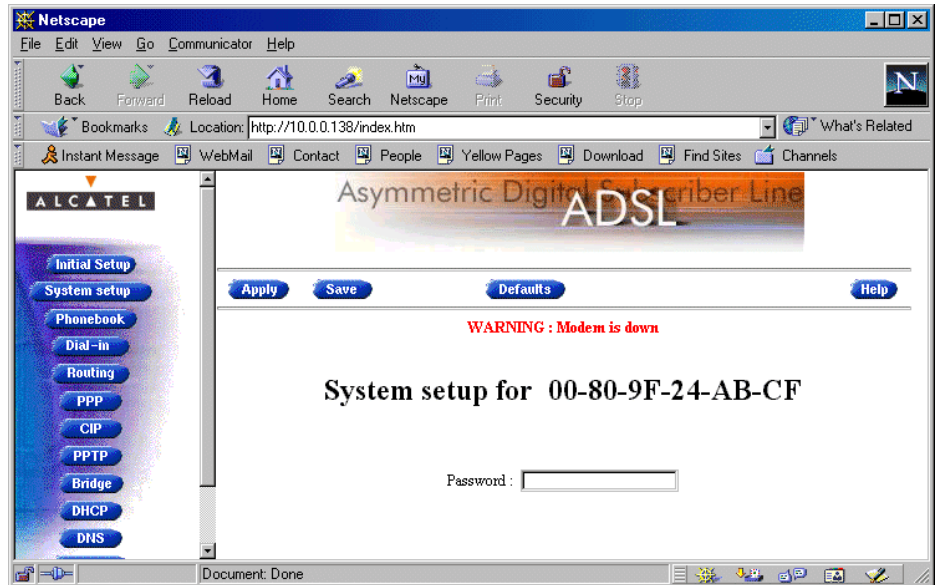

Figure 25 'System Setup' Web Page

Note If a password is supplied, asterisks will appear in the input field.

The next time that you wish to access the **STHome** web pages, the Web browser will request a password.

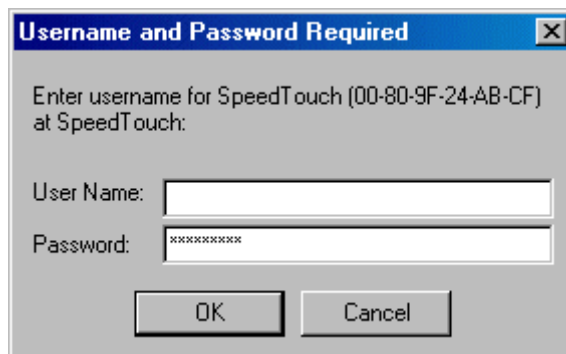

Figure 26 Authentication Window

Supply the password in the appropriate field to acquire full control over the **STHome** again.

Lost System Password Should you lose or forget your password, a **reset to defaults** (Ping-to-Defaults™, or Push Button) must be performed. See section 6.2.2 for more.

7.1.5 The Phonebook Web Page

Definition The **Speed Touch™ Home** Phonebook is like any ordinary phonebook: “A repository for names and numbers”. In contrast to a standard phonebook though, it contains additional connectivity information.

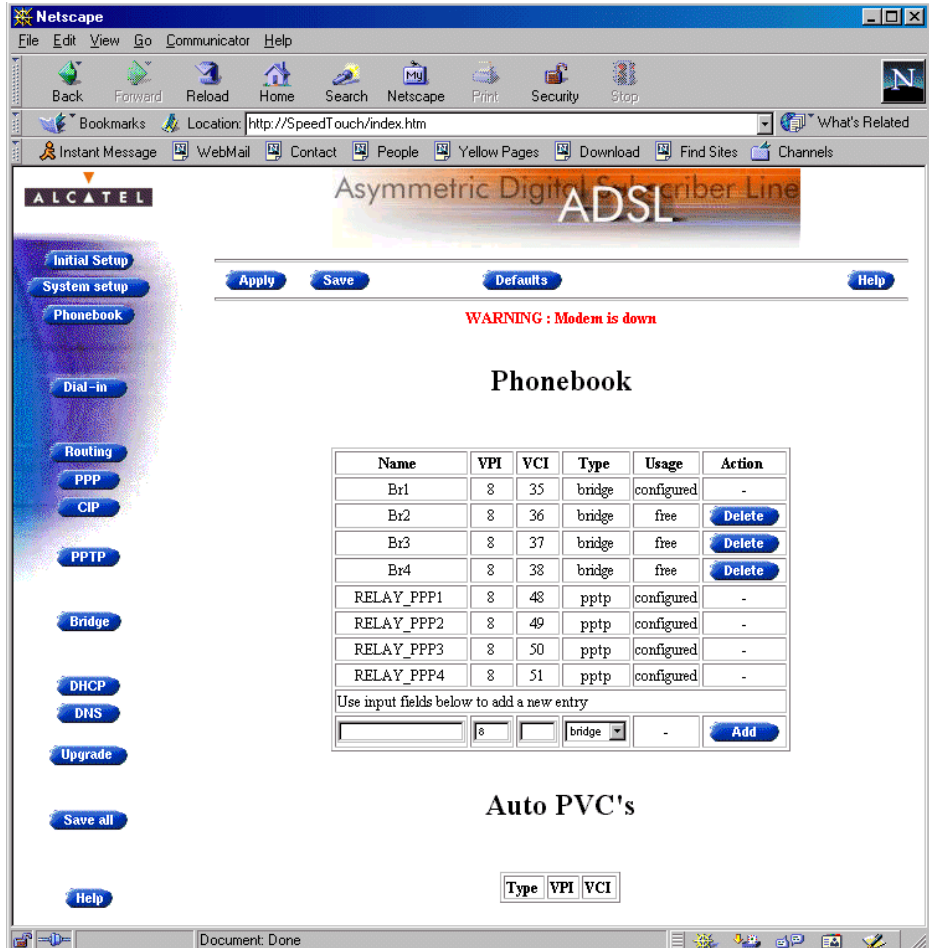

Figure 27 'Phonebook' Web Page

The **STHome** Phonebook contains 5 columns:

► **Name**

This column shows the names or aliases of the virtual connections. Any name can be given to an entry.

Note PPPoA-to-PPTP Relaying Phonebook Entries **may not start with capital 'P' or capital 'T'**.

▶ **VPI/VCI**

The VPI/VCI columns list the VPI/VCI values of the ATM virtual channels that are terminated on the Ethernet port.

The **STHome** VPI values can range from 8 up to 15; its VCI values from 32 up to 511.

▶ **Type**

Represents the packet service that is supported on the virtual channel: either "bridge", or "pptp".

▶ **Usage**

Is a read only column, indicating the state of the virtual channel (e.g. configured, free).

Using the Phonebook

The main function of the **STHome** Phonebook is to present an instant overview of all possible connection entries and their status.

Entries in the Phonebook can be added or changed at will. However, connections that are in use or configured cannot be deleted.

All VCs which are ready to use for ADSL service are indicated by a yellow bar

Configuration

As Phonebook entries do not consume **SThome**'s communications resources, you are free to store all your favoured connections for reference at a later date.

The first time the Phonebook is consulted, it will show the original defaults.

Table 3 *Default Phonebook Entries*

VPI/VCI	Name	Packet Service	State
8/35	Br1	Bridging	Forwarding
8/36	Br2	Bridging	Disabled
8/37	Br3	Bridging	Disabled
8/38	Br4	Bridging	Disabled
8/48	Relay_PPP1	PPPoA-to-PPTP Relay	Configured
8/49	Relay_PPP2	PPPoA-to-PPTP Relay	Configured
8/50	Relay_PPP3	PPPoA-to-PPTP Relay	Configured
8/51	Relay_PPP4	PPPoA-to-PPTP Relay	Configured

7.1.6 The Routing Web Page

Click  to activate the **Speed Touch™ Home's** 'Routing' web page (See figure 28):

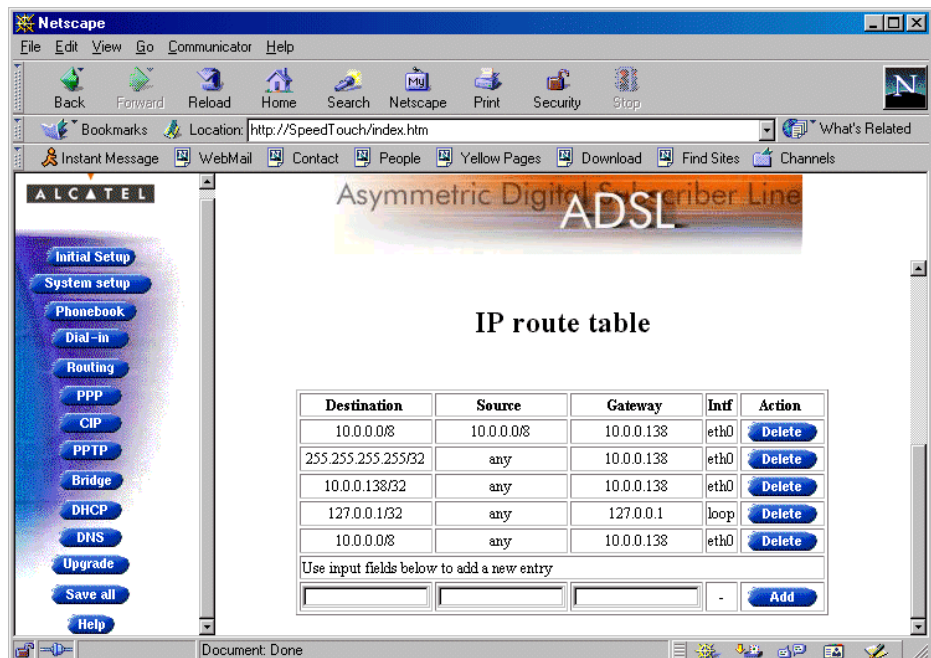

Figure 28 'Routing' Web Page

The 'Routing' web page consists of two tables:

IP Route Table Although the **STHome** has no real IP routing functionality, it has the flexibility to access machines in other networks than its own. The *IP route table* recalls these specific routes. Similar to the *IP address table*, a number of routes are preconfigured.

IP Address Table This table summarizes all IP addresses configured on any of the **STHome** interfaces.

The following fields are shown in the *IP address table* (See figure 29):

► **Intf**

Indicates the interface (Intf) to which the IP parameter set was assigned to.

It can take several values depending on the packet services that are active. The Ethernet (eth0) and the Loopback (loop) are always present.

► **Address**

Shows the IP address of the interface.

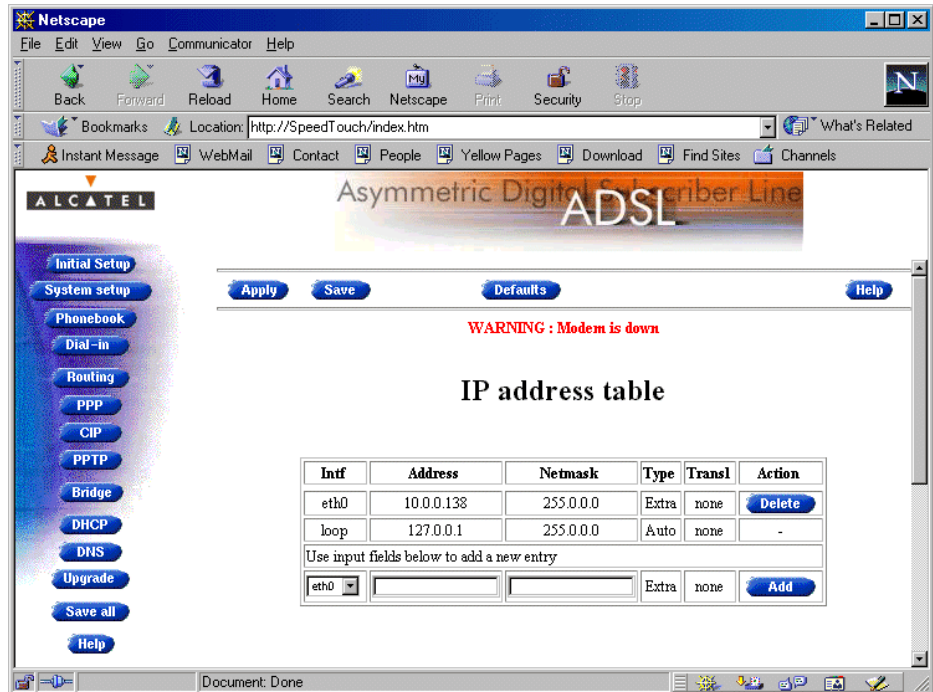

Figure 29 'Routing' Web Page, IP Address Table

► **Netmask**

If available, it shows the Netmask of the interface.

► **Type**

Indicates the origin of the IP parameters and can take following values:

- Auto: Implies that the parameters were acquired automatically through DHCP (for more information see the 'Initial Setup' web page), or are typical standard IP addresses (loop).
- User: Implies that an additional IP parameter set was added through the 'Initial Setup' web page.
- Extra: Implies that an additional IP parameter set was added through the 'Initial Setup' web page. The default IP address 10.0.0.138 is also of this type.
- Temp: Implies that this (additional) IP parameter set was added via a *Ping-of-Life™*.

► **Transl**

This field has no meaning for the **Speed touch™ Home** and will always show 'None'.

To add an IP address, an interface must be selected and the IP address and Netmask in dotted decimal notation specified.

In special circumstances, routes can be manually added to the routing information base, via the bottom row of the 'IP Route table'. In order to add a route the following specific fields must be filled out:

- ▶ Destination IP prefix
- ▶ Source IP prefix
- ▶ Gateway IP address
- ▶ Intf

Note An IP prefix is the combination of an IP address and (Sub)Netmask: e.g. 10.0.0.138/32.

The criteria for a route to be valid are:

- ▶ The destination and source entries must contain correct prefixes
- ▶ The gateway must be directly connected

Note Deleting an IP address automatically removes all related routes in both Routing tables.

7.1.7 The PPTP Connections Web Page

Click **PPTP** to recall the **Speed Touch™ Home** PPPoA-to-PPTP Relaying web page. A 'PPTP Connections' table on this web page presents relevant PPPoA/PPTP connection information.

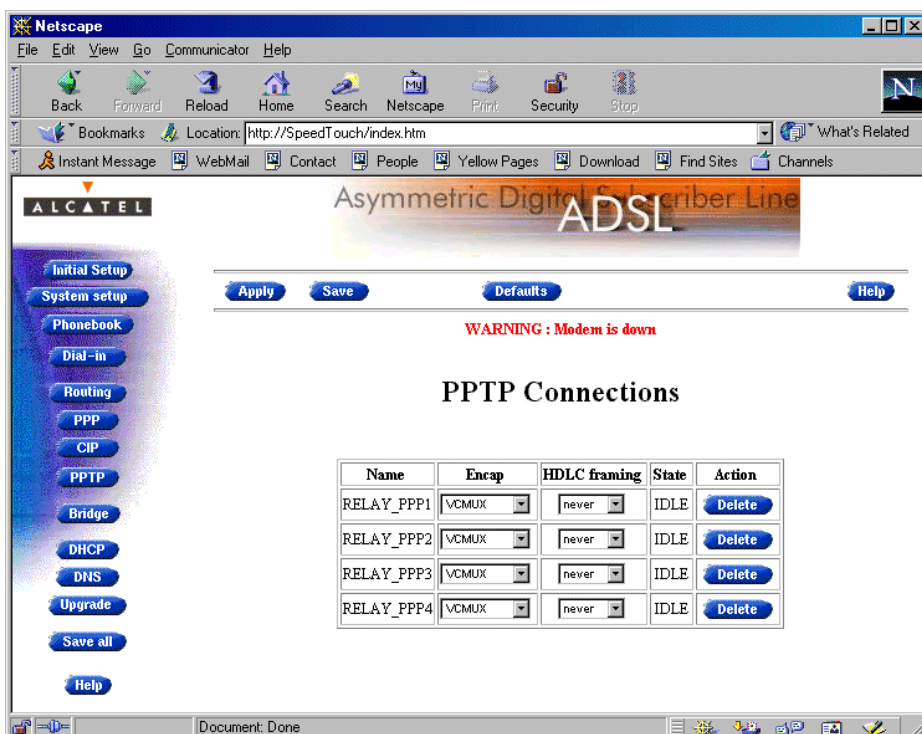

Figure 30 'PPTP Connections' Web Page

The following fields are part of the 'PPTP Connections' table:

▶ **Name**

Indicates the Phonebook name of the PPTP entry.

▶ **Encaps**

Encapsulation/Decapsulation refers to the encapsulation/decapsulation of PPP packets in/from ATM Adaption Layer (AAL)5/ATM.

The **STHome** is compliant with Request For Comments (RFC) 2364 "PPP Over AAL5" and supports both the Logical Link Control (LLC)/Network Link Protocol Identifier (NLPID) method and the VC MULTipleXing (MUX) method. By default the encapsulation/decapsulation method is set to VC MUX.

▶ **High-level Data Link Control (HDLC) Framing**

PPP packets arriving via a PPTP tunnel and PPP packets encapsulated on ATM connections differ in format. The PPP format on AAL5 follows RFC 1661 "Point-to-Point Protocol" (See figure 31) whereas the PPP format within a tunnel follows "Point-to-Point Tunneling Protocol" (See figure 32).

The latter format has two additional bytes in front of the packet (FF 03) inherited from another encapsulation, i.e. RFC 1662 "PPP in HDLC-like framing".

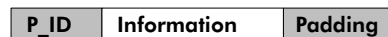

adsl 0760/ 01

Figure 31 PPP ATM Format (RFC 2364:PPP over AAL5).

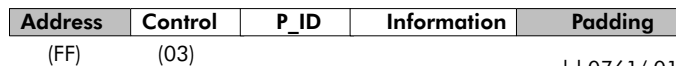

adsl 0761/ 01

Figure 32 PPP/PPTP Tunnel Format.

In order to cope with these PPP packet differences, the **Speed Touch™Home** adapts to the different formats on a 'per connection' base. Although RFC2364 is quite clear with regards to PPP format on AAL5, the **STHome** offers a configuration possibility if interoperability problems should arise.

The PPP/AAL5 format configuration options are:

- **never**
The **STHome** will make sure that FF–03 will never be found in front of a PPP packet encapsulated on an AAL5/ATM connection, independent of the actual format of the PPP packets in the tunnel. This is the **default** setting and follows RFC 2364.
- **always**
The **STHome** will make sure that FF–03 is always in front of a PPP packet encapsulated on an AAL5/ATM connection. Although not supported by RFC 2364, some equipment may rely on this format.
- **keep**
The **STHome** will not change the PPP packet arriving via a tunnel, that is, it will keep the two bytes in front of the packet when it encapsulates the packet.

This configuration possibility applies only to the upstream direction! In the **downstream** direction, the **STHome** will always make sure that FF–03 is in front of the packet prior to put it in a PPTP tunnel.

▶ **State**

The **Speed Touch™Home** allows multiple users to connect simultaneously.

From the moment a PPP/PPTP connection is established, the state field of this connection changes from 'IDLE' to 'In Use (xxx.xxx.xxx.xxx)'. The number in brackets is the IP address of the PC currently using the connection.

7.1.8 The Bridging Web Page

The **STHome** contains an IEEE 802.1D compliant Transparent Bridge that can be reconfigured via this web page.

In principle for Bridging nothing needs to be configured for proper operation as it is a Plug & Play device.

However, should interoperability problems occur, you can easily change the default settings according to the information supplied by the remote organization (ISP or corporate).

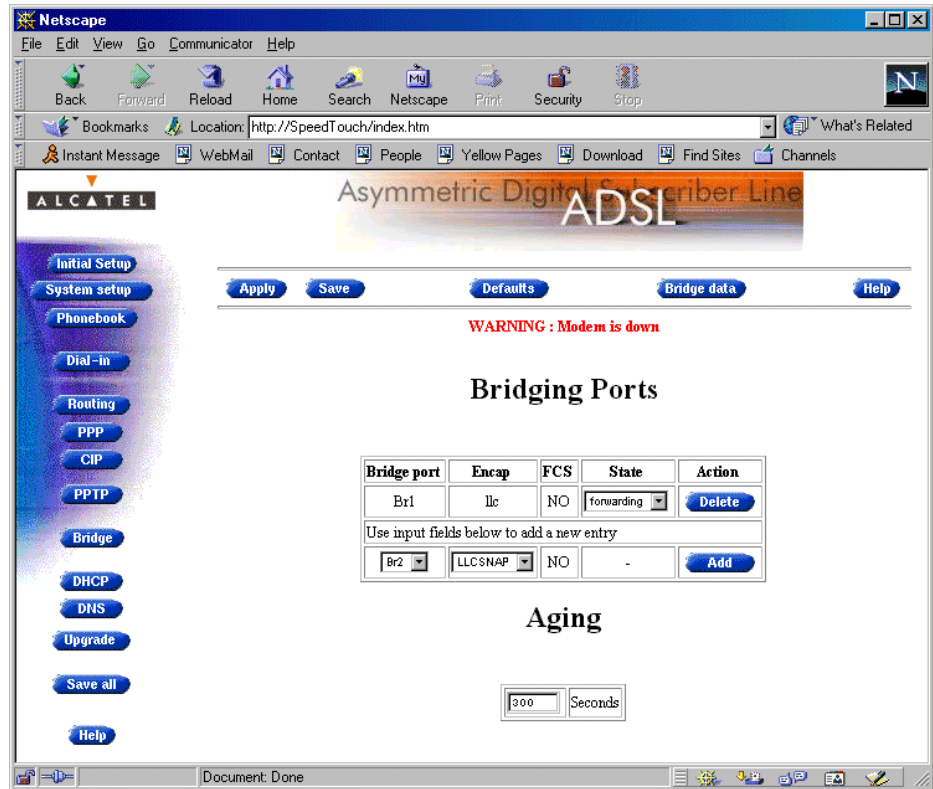

Figure 33 'Bridge Configurations' Web Page

Bridge Ports Table

It contains the following information:

▶ Bridge Port

A Bridge port is in fact the logical equivalent of an interface. By default the **Speed Touch™ Home** supports one local port (Ethernet interface) and up to maximum four remote (ATM/ADSL) ports. Only the remote ports are shown in the table.

▶ Encaps

Encapsulation/Decapsulation refers to the encapsulation/decapsulation of Ethernet V2.0 or IEEE 802.3 frames into/from AAL5/ATM.

The **STHome** is compliant with RFC 1483 "Multiprotocol Encapsulation over ATM Adaptation Layer 5" and supports both the LLC/Sub–Network Access Protocol (SNAP) method and the VC MUX method for Bridged Ethernet V2.0/IEEE 802.3 Protocol Data Unit (PDU).

By default the encapsulation method is set to LLC/SNAP.

▶ **FCS**

Is part of the RFC 1483 Encapsulation method and indicates whether the last four bytes of the MAC frames (Medium Access Control frames, commonly referred to as Ethernet or IEEE 802.3 frames), will be preserved or not.

By default the FCS of MAC frames to be bridged, will not be preserved.

▶ **State**

This field allows you to change the state of the individual LAN ports. The following possibilities are available:

- **forwarding** :Traffic can flow through this port.
- **disabled** : No traffic can flow through this port.
- **learning** : The port is in learning state.

Note

By default only one Bridge port (Br1) is in forwarding state. The 3 other Bridge ports (Br2, Br3 and Br4) are set 'Disabled'.

Deleting bridge ports might be useful if you want to use more than the 8 PPP/PPTP ATM connections currently available.

Aging Timer Box

Further a box containing the **Aging** timer of the bridge internal database is on this page. If the aging time of a MAC entry has expired, this entry will be removed from the database.

The default value of 300s (5 minutes) needs only to be modified in exceptional cases. The permitted range is from 10 seconds to 12 days which is compliant with the IEEE 802.1D bridging standard.

Bridge Data Page

Click [Bridge data](#) to show all of the MAC addresses in the Bridging database.

The MAC addresses are spread over 3 tables:

▶ **Permanent MAC Addresses Table**

The following MAC addresses are resident inside the Bridge:

- The own MAC address of the **Speed Touch™Home**:
e.g. 00-80-9F-05-0B-A0
- The MAC Broadcast address:
FF-FF-FF-FF-FF-FF
- The Bridge Group MAC address:
01-80-C2-00-00-00
- The 16 reserved MAC addresses of IEEE802.1D:
From 01-80-C2-00-00-01
up to 01-80-C2-00-00-0F
- The All LANs Bridge Management Group MAC address:
01-80-C2-00-00-10

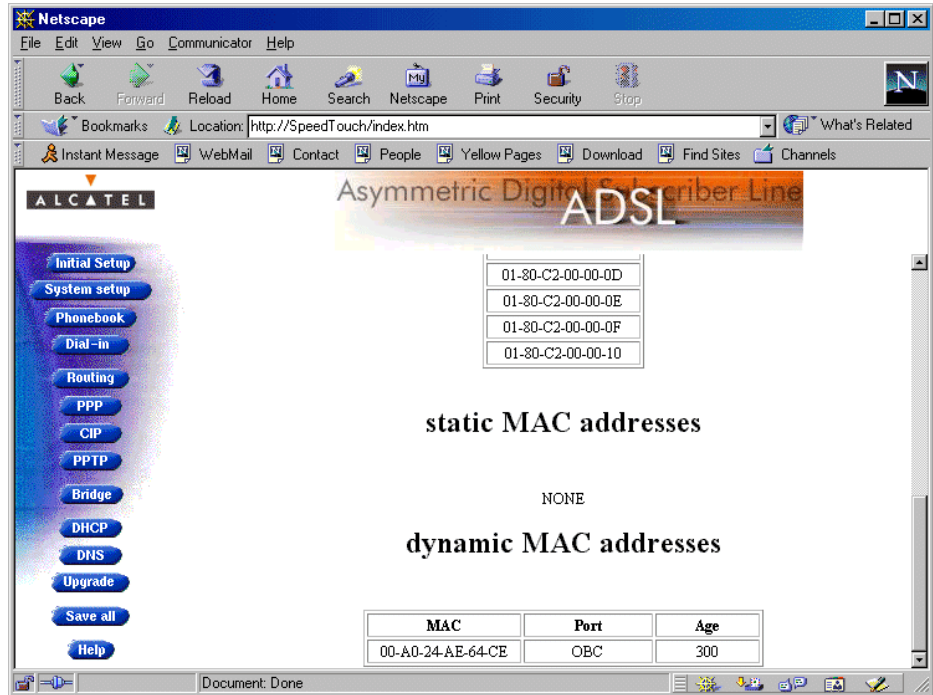

Figure 34 'Bridge Data' Web Page, Static and Dynamic MAC

► **Static MAC Addresses**

Currently no static MAC addresses are configured.

► **Dynamic MAC Addresses Table**

These MAC addresses are learned and aged by the Bridge.

All MAC addresses in this list are automatically entered and removed by the **Speed Touch™ Home** Bridge entity.

The learning process adds MAC addresses received on any of its ports, while the ageing process removes them, if their ageing time has expired.

7.1.9 The DHCP Web Page

The '*DHCP Configuration*' web page allows you to change the **SHome** DHCP server/client settings.

Depending on the size and complexity of your network a few DHCP configurations can be envisaged:

- Simple IP network: no DHCP, i.e. see static configuration earlier in this chapter.
- Medium sized network: **SHome** acting as DHCP server.
- Advanced local network: **SHome** acting as DHCP client.

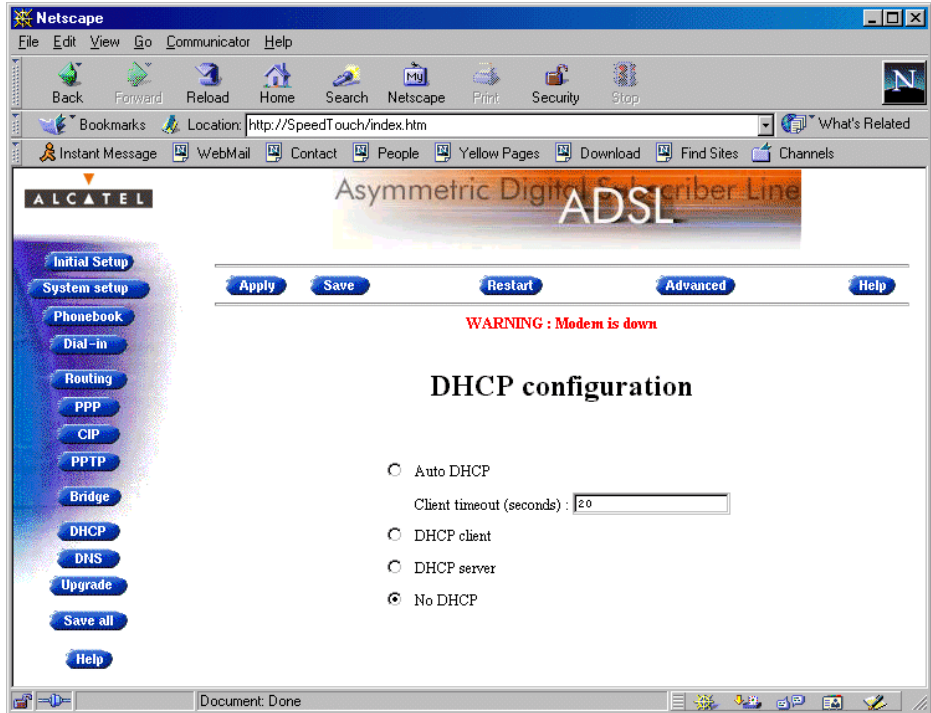

Figure 35 'DHCP Configuration' Web Page

The following configurations are possible:

Auto DHCP

▶ Client timeout (seconds) :

In this mode the **Speed Touch™ Home** probes the local network to verify whether or not, it is the only active DHCP server. If there is another DHCP server on the network, the **STHome** slips into the role of DHCP client. If no response is given after Client-time, the **STHome** will act as DHCP server.



Automatic IP Addressing

Operating systems supporting Automatic IP addressing, might initially not establish IP connectivity with the **STHome**. This because the IP address they assimilated is not within the **STHome** range.

To prevent this problem, please power on your PC(s) after the STHome has come online.

▶ DHCP client

For advanced networks, the role of DHCP server might be performed by an IP node other than the **Speed Touch™ Home** on the local LAN. Typically such functions are attributed to home gateways: computers having better networking capabilities than the other hosts on the home LAN. Therefore set the **STHome** as DHCP client.

▶ DHCP server

For small home LANs it might be interesting to configure all your PCs as DHCP clients and the **STHome** as DHCP server. In this configuration each time a computer boots, it will obtain its IP configuration from the **STHome**. Therefore set the **STHome** as DHCP server.

Note This setting might create side effects with Bridging.

▶ No DHCP

Now DHCP is disabled. It is assumed that all members of the network have static IP addresses.

This is the **STHome** default DHCP mode.

If the **STHome** is configured for 'Auto DHCP' or 'DHCP server', additional configuration might be necessary. Click **Advanced** to access the 'DHCP Server Configuration' web page.

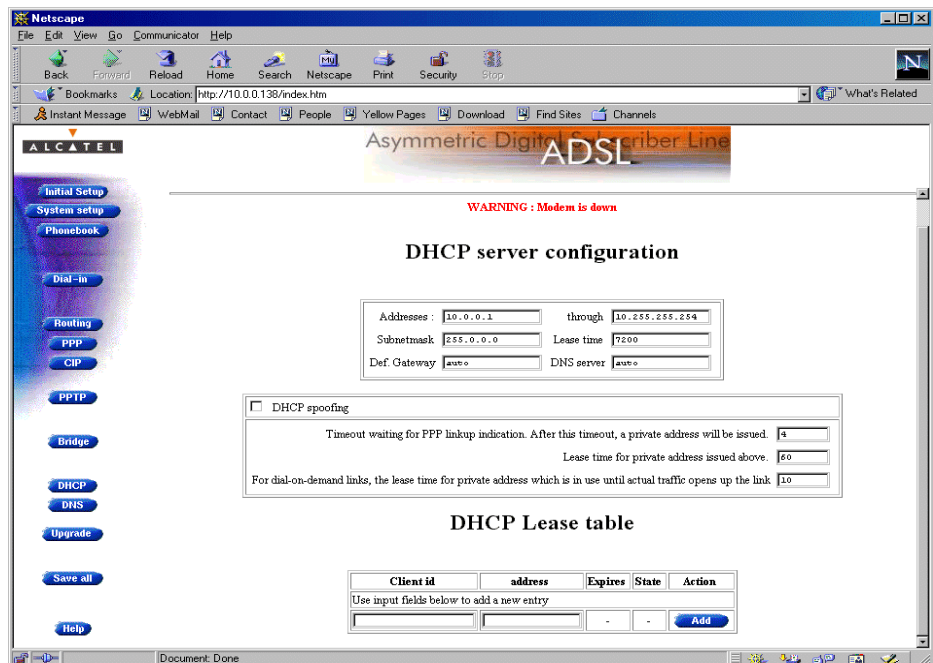

Figure 36 Advanced 'DHCP Server Configuration' Web Page

Three fields are found on this web page:

▶ **DHCP Server Configuration** Field

Allows you to specify the **Speed Touch™Home** DHCP server properties. The available DHCP server options are:

- *Addresses ... through ...*
Allows you to set the range of IP addresses that the DHCP server can choose from.
- *Subnet Mask*
Is needed to specify the subnetting applied to the local network. The default yields no subnetting.
- *Lease Time*
Specifies the lease time IP addresses can be assigned to a device by DHCP.
- *Default Gateway*
Allows you to specify the IP address of the default gateway. By specifying 'auto', there will be referred to the **STHome**.
- *DNS Server*
Allows you to specify the IP address of the DNS Server. By specifying 'auto', there will be referred to the **STHome**.

▶ **DHCP Spoofing** Field

This field has no meaning for the **STHome** and will result in an error message if used.

▶ **DHCP Lease Table**

This table shows current leases and allows you to manually assign IP addresses to devices:

- *Client ID*, the MAC address to which an IP address is leased
- *Address*, the lease IP address
- *State*, indicates if the lease is on (device is up, running and using the lease), off (device is unreachable), or has expired (Timeout timer expired).

To add a lease manually, fill in the appropriate *Client ID*, the IP *Address* of your choice for this client MAC address, and click



7.1.10 The DNS Web Page

Click **DNS** to access the web page allowing you to configure your **Speed Touch™ Home** as local DNS server.

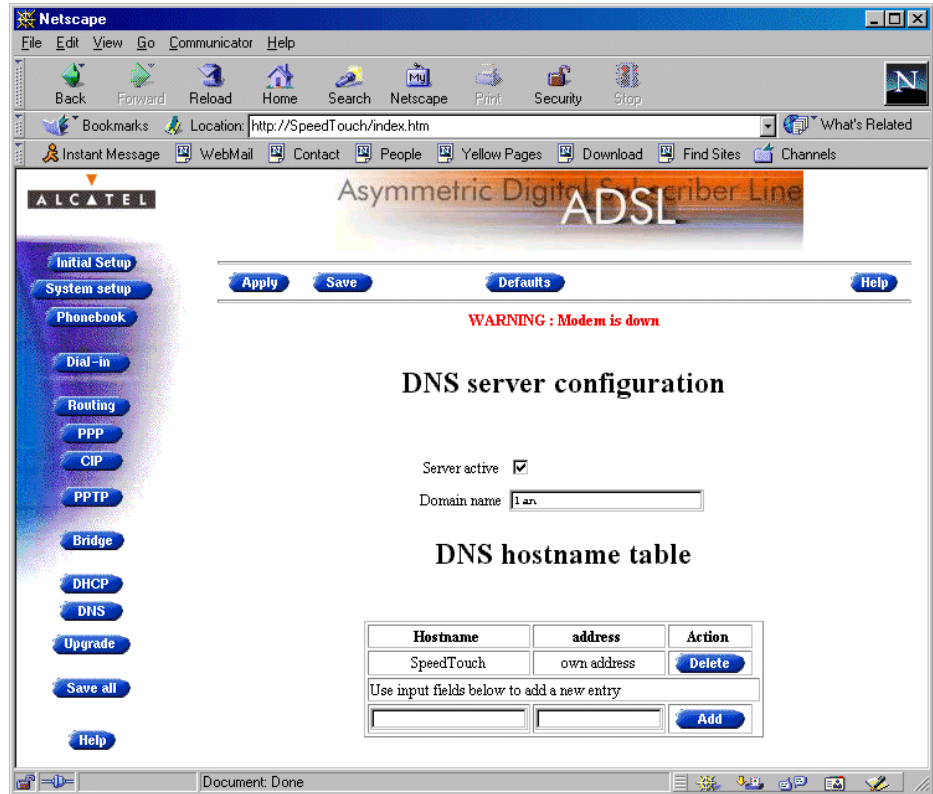

Figure 37 'DNS Configurations' Web Page

The following can be found on this web page:

- ▶ **DNS Server Configuration** Field
 - *Server active*
This option button activates or deactivates the **STHome** DNS server.
 - *Domain Name*
In this field, you specify the domain name of your local network. This name is used by the DNS server to complete the device's DNS Name. By default the domain name is set to 'lan'.
- ▶ **DNS Hostname Table**
Should devices not reveal their hostname in the DHCP request, or even worse, not support DHCP, static entries can be added to the **STHome**'s local DNS database. To do so, add the hostname and corresponding IP address of these devices via the bottom row of the table. Care should be taken however to keep the database consistent.

7.1.11 The Software Upgrade Web Page

The **Speed Touch™Home** supports two software upgrade possibilities:

- ▶ A new version of the software can be **downloaded** from the ADSL network to your **STHome**. This feature is controlled by the ADSL provider. At some point in time he might decide to upgrade the software in your **STHome**. This download will happen almost unnoticed. You will be able to see a change in the software version if you browse to the **STHome's** 'Software Upgrade' page.
- ▶ Alternatively you can **upload** new **STHome** software packages from a PC on your local LAN.

Click **Upgrade** to display the 'Software Upgrade' page which allows you to upload the new(er) software.

Prior to performing the upgrade, the software must be readily available on either a floppy, a CD-rom or resident on your hard disk.

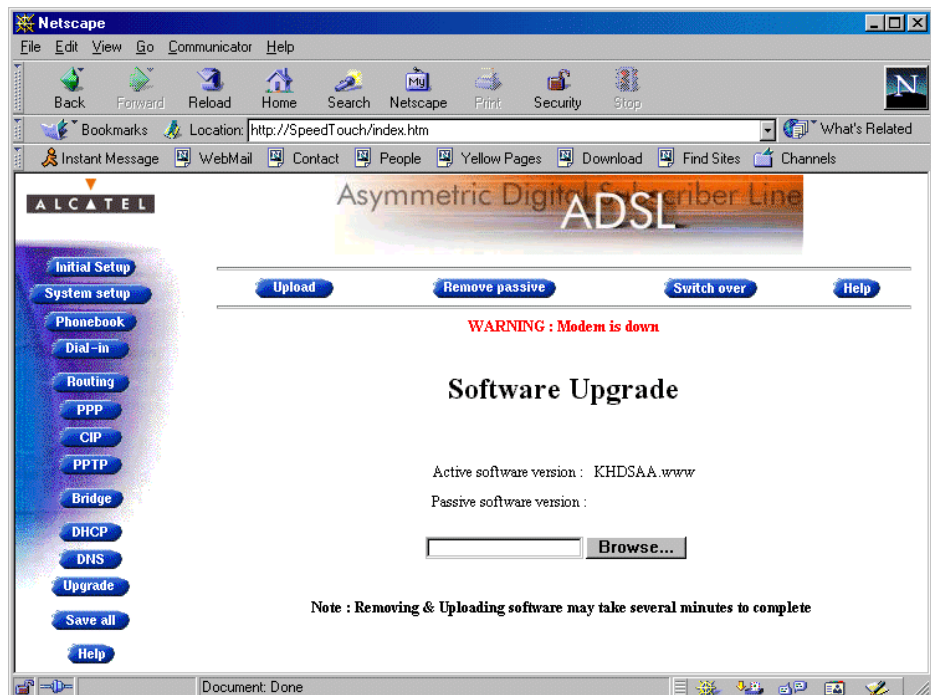

Figure 38 'Software Upgrade' Web Page

The following fields are found on this web page:

- ▶ **Active Software Version**

Indicates the software version that the **STHome** is currently using.

▶ **Passive Software Version**

Indicates the software version resident in the **Speed Touch™ Home**, but not used. This could be a newer version which is yet to be switched to active, but also a dormant older version.

▶ **Software Path Input Field**

This field allows you to specify the path to the **STHome** software upgrade package to be uploaded. You can also browse to it, using the 'Browse' button.

In the header frame the following buttons can be found:

- ▶ The **Upload** button starts the upload process: the software package indicated by the path, specified in the Software Upgrade Input field, will be transferred to the **STHome** to become the passive software version.

Prior to start an upload:

- A software package must be located by the software Upgrade Input field.
 - The passive software version field must be empty. This can be done by pressing the **Remove passive** button in the top banner.
- ▶ Click **Remove passive** to remove the passive software version from the **STHome**.
- ▶ Clicking **Switch over** switches active and passive software versions after a successful upload. Your **STHome** will reboot and come online again with the new version.

7.2 Command Line Interface via Telnet

Via the Ethernet interface of the **STHome** you can execute Command Line Interface (CLI) commands from any PC on the LAN.

You must first gain access to the **STHome**, by opening a TCP/IP Telnet session.

1. Open a Telnet session and supply **STHome**'s IP address or DNS hostname.
2. The **STHome** will prompt you with `User :`. Press 'Enter'.
3. If required, fill in the password.
4. The CLI prompt `=>` appears.

From the prompt you can enter your commands. Typing **help** will show you the available commands.

CLI access is closed either via time out or by closing Telnet.

8 Troubleshooting

Problem	Solution
Speed Touch™Home modem does not work (no LEDs on top light up)	Make sure the STHome modem is plugged in
	Make sure the STHome modem is turned on
ATMF connection does not work	Make sure the cable is securely connected to ATMF-25 connector and that you are using the correct cable type for your ATM equipment
Ethernet connection does not work	Make sure the cable is securely connected to 10Base-T connector and that you are using the correct cable type for your Ethernet equipment
Poor Speed Touch™Home modem performance	Make sure the STHome modem is installed as described in the instructions provided in this User Guide
	Make sure the STHome modem has adequate ventilation. Place the modem on an even, hard surface. Do not stack books or paper on the modem.
	Make sure in-house wiring is routed away from possible sources of interference, such as electrical wiring
Power/Sync LED is constantly green, but no traffic passes through	Restart the STHome modem
Power/Sync LED remains constantly Red	Restart the STHome modem

If the troubleshooting tips listed above have not resolved the problem, contact your local distributor for assistance.

Abbreviations

AAL	ATM Adaption Layer
ADSL	Asymmetric Digital Subscriber Line
ATM	Asynchronous Transfer Mode
CLI	Command Line Interface
DHCP	Dynamic Host Configuration Protocol
DNS	Domain Name System
DTE	Data Terminal Equipment
EMC	Electro Magnetic Compatibility
HDLC	High-level Data Link Control
HTML	Hyper Text Markup Language
HTTP	Hyper Text Transfer Protocol
IP	Internet Protocol
ISP	Internet Service Provider
LAN	Local Area Network
LED	Light Emitting Diode
LLC	Logical Link Control
MAC	Medium Access Control
MDI	Medium Dependent Interface
MDI-X	Medium Dependent Interface – Crossed
MUX	MUltipleXing
NIC	Network Interface Card
NLPID	Network Link Protocol Identifier
OS	Operating System
PC	Personal Computer
PDU	Protocol Data Unit
POST	Power On Self Test
POTS	Plain Old Telephone Service
PPP	Point-to-Point Protocol
PPTP	Point-to-Point Tunneling Protocol
RAS	Remote Access Services
RFC	Request For Comments

ROW	Rest Of the World
SNAP	Sub–Network Access Protocol
TCP	Transmission Control Protocol
URL	Uniform Resource Locator
VC	Virtual Channel
VCI	Virtual Channel Identifier
VCs	Virtual Channels
VP	Virtual Path
VPI	Virtual Path Identifier
VPN	Virtual Private Network
WAN	Wide Area Network
WWW	World Wide Web

Appendix A Product Code Tables

The exact functionality of the **Speed Touch™ Home** modem depends on the model that you have purchased. Each model has a unique eight part **product code**. The product code is printed on one of the labels that can be found on the bottom of the **STHome**.

The product code reflects the functionality of your **STHome** as explained below.

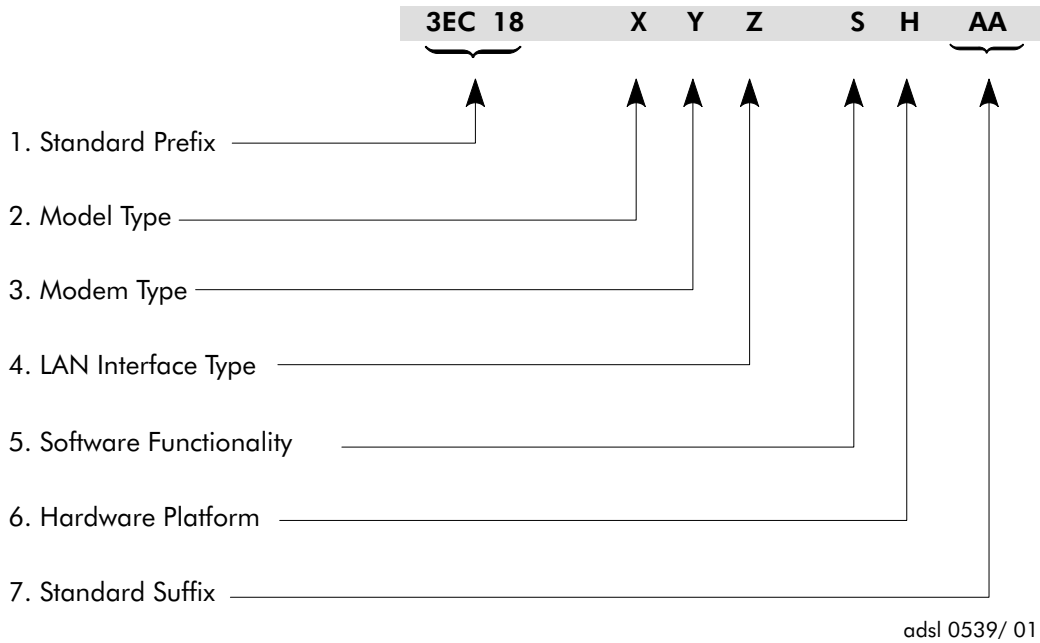

Figure 39 STHome Product Code

X field The 'X field' reflects the physical specifications of your **Speed Touch™ Home** as listed in table 4.

Table 4 "X Field" Specification

X	Model Reference	AC/DC	Plug Type	Wire A/B
2	US 2/5 model	120V/9V	US	2/5
5	UK/Sing model	230V/9V	UK/Sing	3/4
6	ROW(*) model	230V/9V	ROW	3/4
7	Australia model	240V/9V	AUS	3/4
8	US 3/4 model	120V/9V	US	3/4
9	Korea model	220V/9V	Korea	3/4

Note (*) : Rest Of the World (ROW)

Y field The 'Y field' specifies the modem type (See table 5).

Table 5 "Y Field" Specification

Y	Modem Type
0	Full rate, G.dmt, ANSI T1.413 only, POTS overlay

Z field The 'Z field' specifies the interface type (See table 6).

Table 6 "Z Field" Specification

Z	Interface type
4	10Base-T interface
5	ATMF-25 & 10Base-T interface

S field The '*S field*' specifies the default software package (See table 7).

Table 7 "*S Field*" Specification

S	Default Software Package
B	Bridging + PPPoA/PPTP
E	Bridging + PPPoA/PPTP + MAC filtering

H field The '*H field*' specifies the Hardware Platform (See table 8).

Table 8 "*H Field*" Specification

H	Hardware Platform
C	R3.2 (3MB FLASH/ADNTF)
E	R3.2 (Korea, without Power Supply)

Appendix B Hardware Reference

B.1 Connector Pinout

Table 9 Connector Pinout

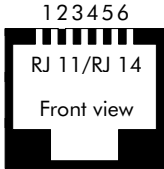
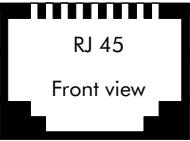
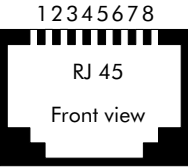
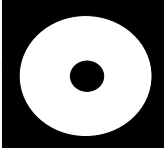
Connector	Pin No.	Signal Name	Function	Model Reference(**)
 <p>LINE</p>	2	Wire A	Subscriber line wire A	US 2/5 model
	3	Wire A	Subscriber line wire A	all other models
	4	Wire B	Subscriber line wire B	
	5	Wire B	Subscriber line wire B	US 2/5 model
 <p>ATMF-25</p>	1	Rx+	Receive data from DTE* (+)	
	2	Rx-	Receive data from DTE (-)	
	7	Tx+	Transmit data to DTE (+)	
	8	Tx-	Transmit data to DTE (+)	
 <p>10BASE-T</p>	1	Rx+	Receive data from DTE (+)	
	2	Rx-	Receive data from DTE (-)	
	3	Tx+	Transmit data to DTE (+)	
	6	Tx-	Transmit data to DTE (-)	
 <p>DC</p>	Inner	+9V _{DC}	Power supply adapter connection (+)	
	Outer	GND	Power supply adapter connection (-)	

Note (*) : Data Terminal Equipment (DTE)

Note (**): Please refer to Table 4 for **Speed Touch™ Home's** Model Reference description.

Note Connector pins not mentioned are not connected.

B.2 Power Supply Adapter

The **Speed Touch™Home** is equipped with one of the following portable power supply adapters listed in table 10. Due to the special characteristics of the output class II AC adapter, use only the **AULT Incorporated** types or equivalents listed in the table. As you see, the plugtype depends on the product code's "X-field" specification (See also Appendix A).

Table 10 Power Adapters for STHome

Model Reference	AC/DC	Plugtype	AULTinc. Model (or equivalent)
US 2/5 model US 3/4 model	120V/9V	North America wall plug in style	P48-091000-Axxxx
UK/Sing model	230V/9V	UK wall plug	F48-091000-Axxxx
ROW model	230V/9V	Euro wall plug	D48-091000-Axxxx
Australia model	240V/9V	Australian wall plug	E48-091000-Axxxx
Korea model	220/9V	Korea wall plug	Q48-091000-Axxxx

The supplied adapter has the following output specifications:

- ▶ 9V_{DC}/1A unregulated output voltage
- ▶ Maximum 860 mV_{eff} ripple voltage
- ▶ Maximum 1A output current
- ▶ Limited power source (according to IEC/EN 60950, sub-clause 2.11 and UL1950).

B.3 Straight-through Cable Layout (LAN Cable)

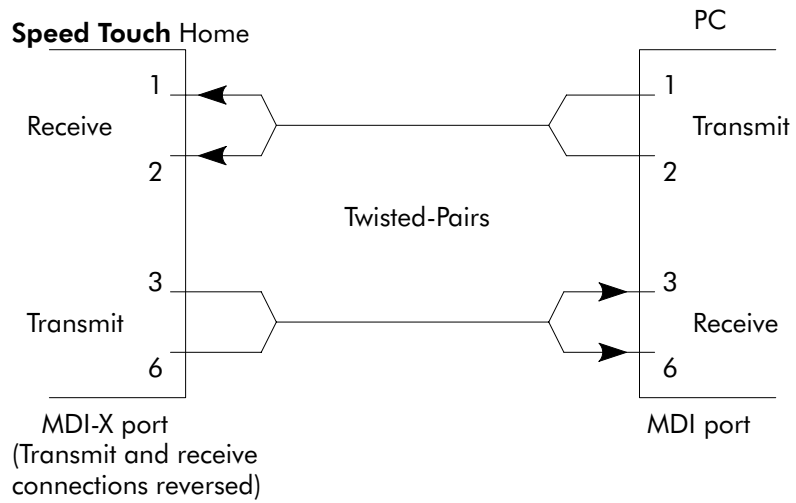

Figure 40 MDI-X Internal Crossover

B.4 Crossover Cable Layout

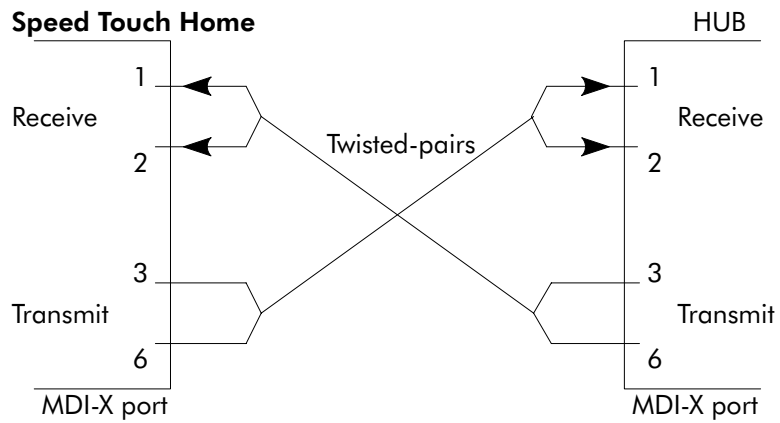

Figure 41 MDI-X to MDI-X External Crossover

Appendix C Speed Touch Home Default Settings

C.1 Global Speed Touch Home Default settings

IP Address	10.0.0.138
DNS Name	SpeedTouch
DNS Domain Name	lan
DHCP Mode	No DHCP

C.2 IEEE 802.1D Transparent Bridging and Related Defaults

Phonebook Entries *Table 11 Default Bridging Phonebook Entries*

Name	VPI Value	VCI Value	State
Br1	8	35	Configured
Br2	8	36	Free
Br3	8	37	Free
Br4	8	38	Free

ATM Encapsulation RFC1483 LLC/SNAP for Bridged PDUs (FCS not preserved)

Bridge Parameters *Table 12 Bridging Parameters*

Parameter	Default value	Description
FCS Preservation	No	Frame Check Sequence
Compression	No	Tinygram Compression

Bridge Configuration 1 Port (Br1) set in forwarding state

Ageing Time 5 minutes

C.3 PPPoA-To-PPTP Relaying Defaults

Phonebook Entries *Table 13 Default Relaying Phonebook Entries*

Name	VPI Value	VCI Value	State
RELAY_PPP1	8	48	Configured
RELAY_PPP2	8	49	Configured
RELAY_PPP3	8	50	Configured
RELAY_PPP4	8	51	Configured

ATM Encapsulation RFC2364 VC MUX for PPP PDUs

C.4 Global Default VPI/VCI Values

ATMF Interface *Table 14 ATMF VPI/VCI Values*

VPI	VCI	Service Channel
0..5	0..511	End-user defined

Ethernet Interface *Table 15 Ethernet VPI/VCI Values*

VPI	VCI	Service Channel
0	21	ADSL/ATM Loopback Channel
1	21	
8	35	Bridging Service
8	36	Bridging Service
8	37	Bridging Service
8	38	Bridging Service
8	48	PPPoA/PPTP Relaying Service
8	49	PPPoA/PPTP Relaying Service
8	50	PPPoA/PPTP Relaying Service
8	51	PPPoA/PPTP Relaying Service
15	16	SNMP Agent Communication Channel
15	64	SW Download Channel

Appendix D Safety

This Appendix provides basic Safety Information on your **Speed Touch™Home**.

Prior to using the **STHome**, read this Appendix carefully.

D.1 Safety Instructions

▶ **Read and understand all instructions**

Follow all warnings and instructions marked on the product.

▶ **Climatic conditions**

The **STHome** equipment is intended for:

- **In-house stationary desktop use**; the maximum ambient temperature may not exceed 40°C (104°F).
- It must **not** be mounted **in a location exposed to direct or excessive solar and/or heat radiation**.
- It **must not** be **exposed to heat trap conditions and must not be subjected to water or condensation**.
- It must be installed **in a Pollution Degree 2 environment**.

▶ **Cleaning**

Unplug this product from the wall outlet before cleaning. Do not use liquid cleaners or aerosol cleaners. Use a damp cloth for cleaning.

▶ **Water and moisture**

Do not use this product near water, for example, near a bathtub, wash bowl, kitchen sink, laundry tub, in a wet basement or near a swimming pool.

▶ **Power supply adapter**

The **STHome** comes with a portable power supply adapter.

Due to the special characteristics of the output of the class II AC adaptor, only use the models or equivalent listed in the power adapter table in Appendix B.

▶ **Power sources**

The powering of this product must adhere to the power specifications indicated on the marking labels. If you are unsure of the type of power supply to your home, consult your product dealer or local power company.

The **mains socket outlet** must be **close to the equipment** and easily accessible.

The **Speed Touch™ Home** equipment is **not** intended to be connected **to an IT-type** power system.

▶ **Power cord protection**

Do not allow anything to rest on the power cord. Do not locate this product where the cord will be subject to persons walking on it.

▶ **Overloading**

Do not overload wall (mains) outlets and extension cords as this increases the risk of fire or electric shock.

▶ **Servicing**

To reduce the risk of electric shock, do not disassemble this product. None of its internal parts are user-replaceable; therefore, there is no reason to access the interior. Opening or removing covers may expose you to dangerous voltages. Incorrect reassembly could cause electric shock if the appliance is subsequently used.

If service or repair work is required, take it to a qualified service dealer.

▶ **Damage requiring service**

Unplug this product from the wall outlet and refer servicing to qualified service personnel under the following conditions:

- When the power supply cord or plug is damaged or frayed.
- If liquid has been spilled into the product.
- If the product has been exposed to rain or water.
- If the product does not operate normally.
- If the product has been dropped or damaged in any way.
- If the product exhibits a distinct change in performance.

▶ **Modem/Telephone use**

Avoid using a modem/telephone (other than a cordless type) during an electric storm. There is a slight risk of electric shock caused by lightning.

Do not use the telephone to report a gas leak in the vicinity of the leak.

If **telephone service** is required on the same line, a **central splitter** or **distributed filter(s) must be installed** for optimal ADSL performance. Depending on your ADSL configuration and type of splitter/filters, installation must be carried out by **qualified service personnel**. Consult your telephone company or ADSL service provider for instructions.

STORE THESE INSTRUCTIONS CAREFULLY !

D.2 Safety Standards

The **Speed Touch™Home** complies with the following safety standards:

- ▶ EN 60950, 2nd ed. (1992), including amendments 1 (1993), 2 (1993), 3 (1995) and 4 (1997)
- ▶ IEC 60950, 2nd ed. (1991), including amendments 1 (1992), 2 (1993), 3 (1995) and 4 (1996)

The external interfaces on the rear panel are classified as follows:

- ▶ **Line:** TNV circuit, subjected to overvoltages (TNV-3)
- ▶ **10Base T/MDI-X:** SELV circuit
- ▶ **ATMF-25:** SELV circuit
- ▶ **DC:** Power receptacle

Appendix E Agency Regulatory Notices

E.1 FCC Class B Notice – United States only

Federal Communications Commission (FCC) Statements

This device has been tested and found to comply with the limits for a Class B digital device, pursuant to Part 15 of the FCC Rules. These limits are designed to guarantee this device doesn't harmfully interfere with, or harmfully be interfered by other devices.

Radio Frequency Interference Statement

Note: this equipment has been tested and found to comply with the limits for a Class B digital device, pursuant to Part 15 of the FCC Rules. This equipment generates, uses and can radiate radio frequency energy. If not installed and used in accordance with the instructions, it may cause interference to radio communications.

The limits are designed to provide reasonable protection against such interference in a residential situation. However, there is no guarantee that interference will not occur in a particular installation. If this equipment does cause harmful interference to radio or television reception, which can be determined by turning the equipment on and off, the user is encouraged to try correct the interference by one or more of the following measures:

- ▶ Reorient or relocate the receiving antenna of the affected radio or television.
- ▶ Increase the separation between the equipment and the affected receiver.
- ▶ Connect the equipment and the affected receiver to power outlets on separate circuits.
- ▶ Consult the dealer or an experienced radio/TV technician for help.

Modifications

The FCC requires the user to be notified that any changes or modifications made to this device that are not expressly approved by Alcatel may void the user's authority to operate this equipment.

E.2 Canadian DOC Class B Notice

Notification of Canadian RF Interference Statements

This digital apparatus does not exceed the Class B limits for radio noise emissions from digital apparatus as set out in the radio interference regulations of the Canadian Department of Communication.

Le présent appareil numérique n'émet pas de bruits radioélectriques dépassant les limites applicable aux appareils numérique de classe B prescrites dans le règlement sur le brouillage radioélectrique édicté par le Ministère des Communications du Canada.

E.3 European Community Declaration of Conformity

Products with the  Marking comply with both Electro Magnetic Compatibility (EMC) and Low Voltage Directives issued by the Commission of the European Community.



EC DECLARATION OF CONFORMITY

We ALCATEL BELL NV (Ltd liability company)
Francis Wellesplein 1
2018 Antwerp
Belgium

declare under our sole responsibility that the products
A1000 ADSL Speed Touch Home and A1000 ADSL Speed Touch Pro
(report ref. 3EC 16403 0001 QZZZA)

to which this declaration relates is in conformity with the following standard(s) or other normative document(s) provided that it is installed, maintained and used in the application for which it is made, with respect of the "professional practices" relevant installation standards and manufacturer's instructions:

EN 50082-1 & EN 55022:
- Installation in telecom areas.
- Normal priority of service.
- All interfaces are indoor cabling.
- Test report ETE-036 dd. 16.05.1999

EN60950 & IEC950 (including A1,A2,A3,A4):
- Test report ET-S-206 dd. 25.06.1999

following the provisions of the 89/336/EEC, 73/23/EEC and 93/68/EEC Directives.

Certificate no: CERT/VQ1/99046

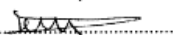
Antwerp 20-8-99

.....
(place and date of issue)

M. De Prycker
President
Internet Access Division
(signature)

Figure 42 EC Declaration of Conformity